

Last time: Summary



- **Definition of AI?**
- **Turing Test?**
- **Intelligent Agents:**
 - Anything that can be *viewed as perceiving* its **environment** through **sensors** and **acting** upon that environment through its **effectors** to maximize progress towards its **goals**.
 - PAGE (Percepts, Actions, Goals, Environment)
 - Described as a Perception (sequence) to Action Mapping: $f: \mathcal{P}^* \rightarrow \mathcal{A}$
 - Using look-up-table, closed form, etc.
- **Agent Types:** Reflex, state-based, goal-based, utility-based
- **Rational Action:** The action that maximizes the expected value of the performance measure given the percept sequence to date

Outline: Problem solving and search



- **Introduction to Problem Solving**
- **Complexity**
- **Uninformed search**
 - Problem formulation
 - Search strategies: depth-first, breadth-first
- **Informed search**
 - Search strategies: best-first, A*
 - Heuristic functions

Example: Measuring problem!

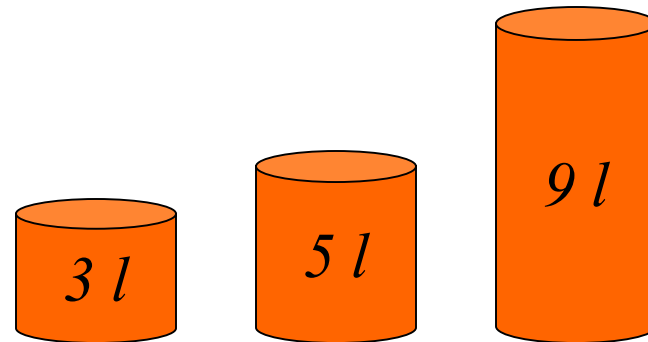

Problem: Using these three buckets,
measure 7 liters of water.

Example: Measuring problem!

- (one possible) Solution:

a	b	c	
0	0	0	start

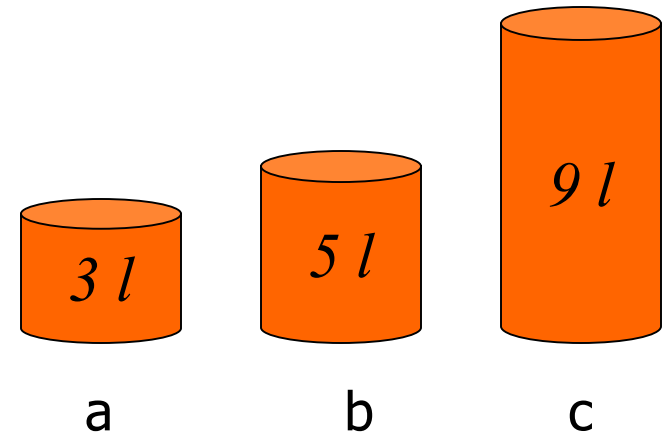

Example: Measuring problem!

- (one possible) Solution:

a	b	c	
0	0	0	start
3	0	0	

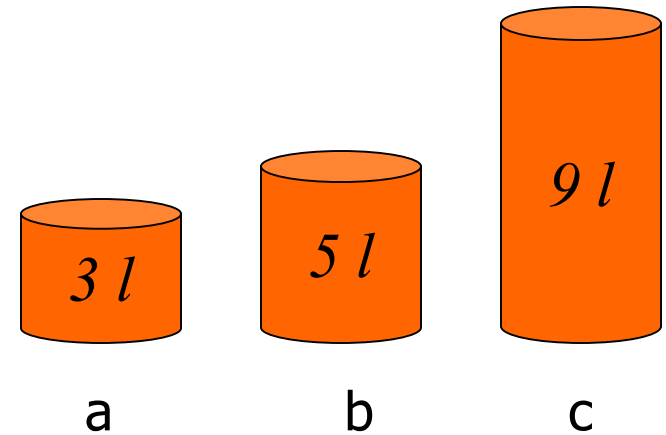

Example: Measuring problem!

- (one possible) Solution:

a	b	c	
0	0	0	start
3	0	0	
0	0	3	

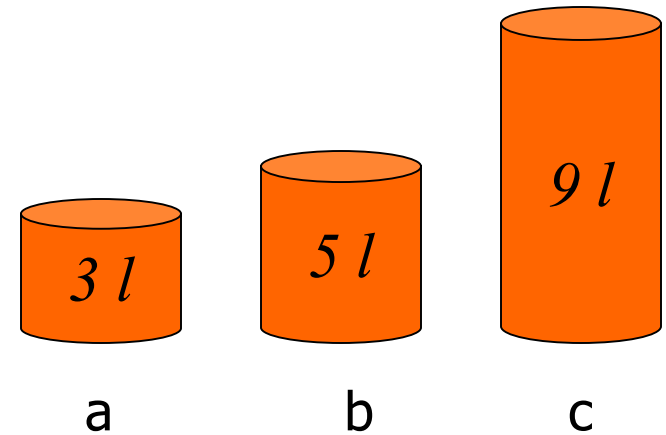

Example: Measuring problem!

- (one possible) Solution:

a	b	c	
0	0	0	start
3	0	0	
0	0	3	
3	0	3	

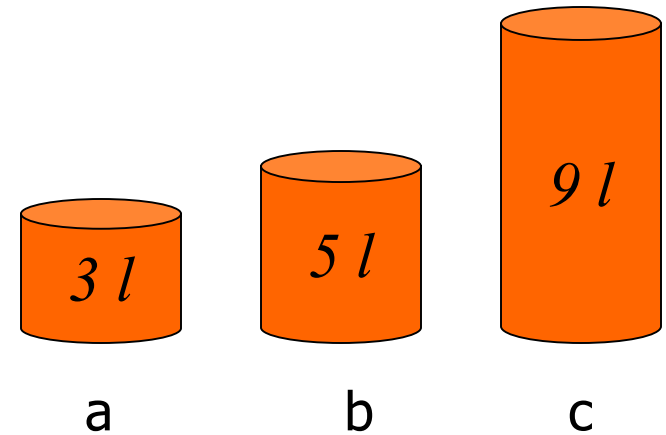

Example: Measuring problem!

- (one possible) Solution:

a	b	c	
0	0	0	start
3	0	0	
0	0	3	
3	0	3	
0	0	6	

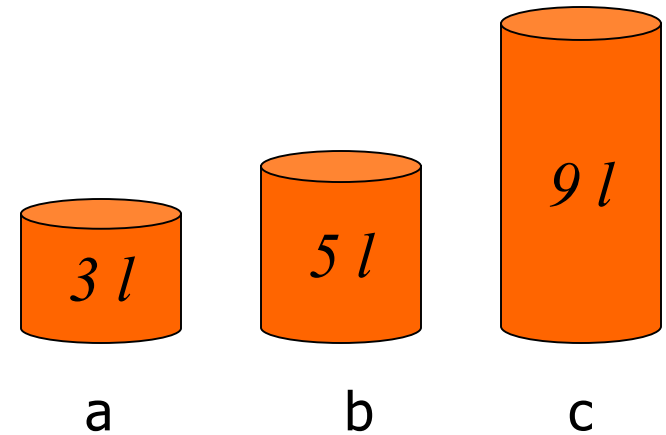

Example: Measuring problem!

- **(one possible) Solution:**

a	b	c	
0	0	0	start
3	0	0	
0	0	3	
3	0	3	
0	0	6	
3	0	6	

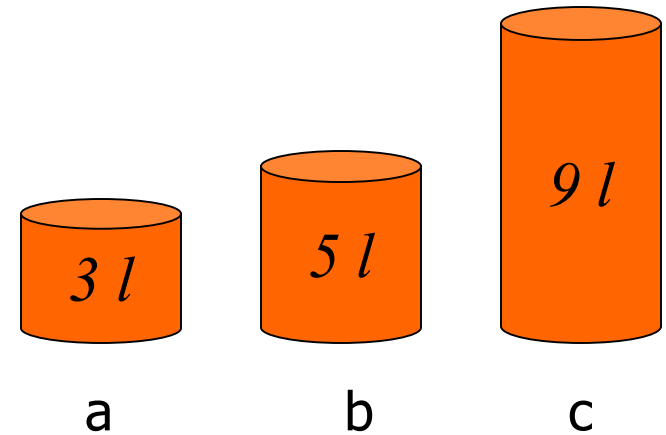

Example: Measuring problem!

- (one possible) Solution:

a	b	c	
0	0	0	start
3	0	0	
0	0	3	
3	0	3	
0	0	6	
3	0	6	
0	3	6	

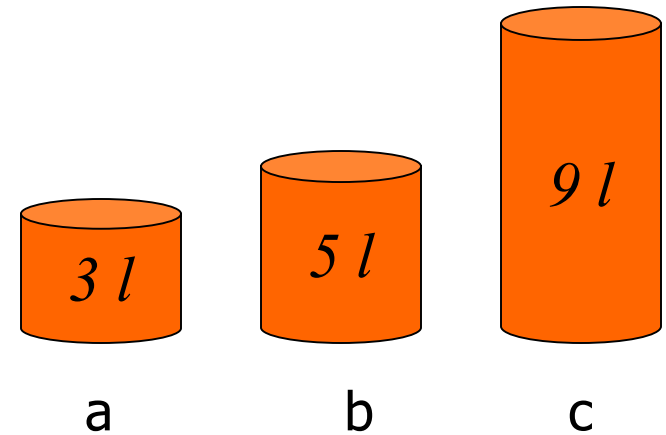

Example: Measuring problem!

- (one possible) Solution:

a	b	c	
0	0	0	start
3	0	0	
0	0	3	
3	0	3	
0	0	6	
3	0	6	
0	3	6	
3	3	6	

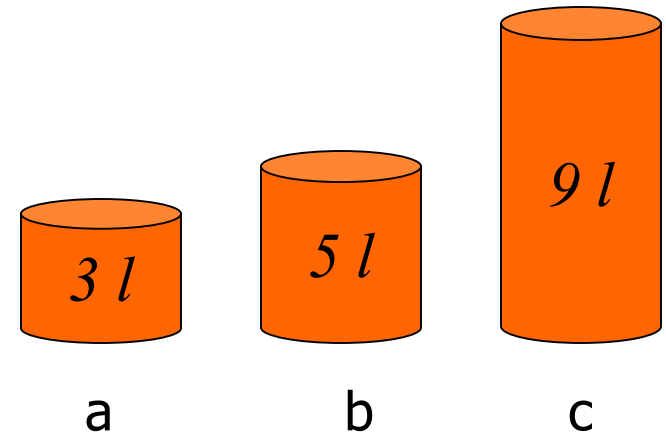

Example: Measuring problem!

- (one possible) Solution:

a	b	c	
0	0	0	start
3	0	0	
0	0	3	
3	0	3	
0	0	6	
3	0	6	
0	3	6	
3	3	6	
1	5	6	

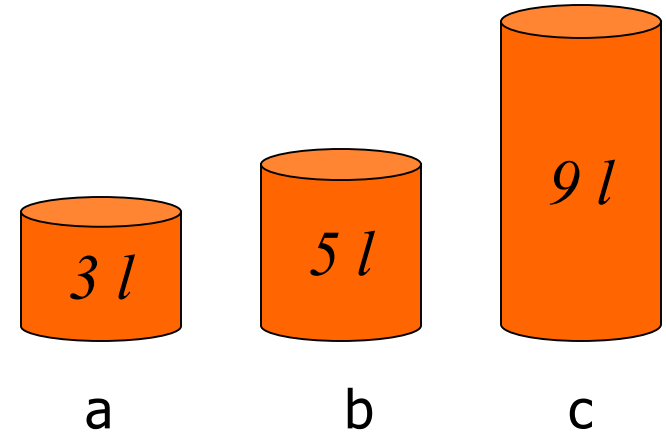

Example: Measuring problem!

- (one possible) Solution:

a	b	c	
0	0	0	start
3	0	0	
0	0	3	
3	0	3	
0	0	6	
3	0	6	
0	3	6	
3	3	6	
1	5	6	
0	5	7	goal

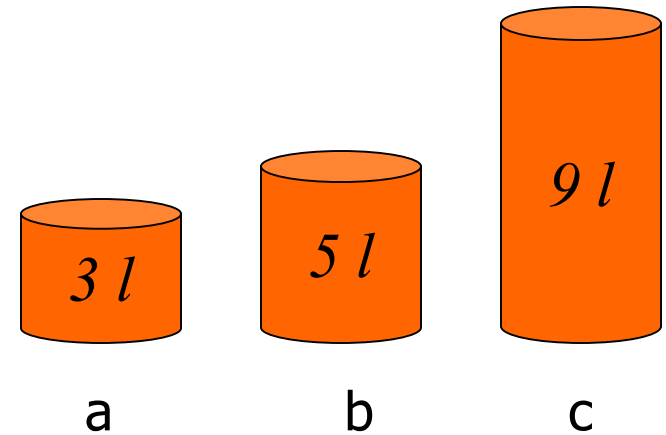

Example: Measuring problem!

- **Another Solution:**

a	b	c	
0	0	0	start
0	5	0	

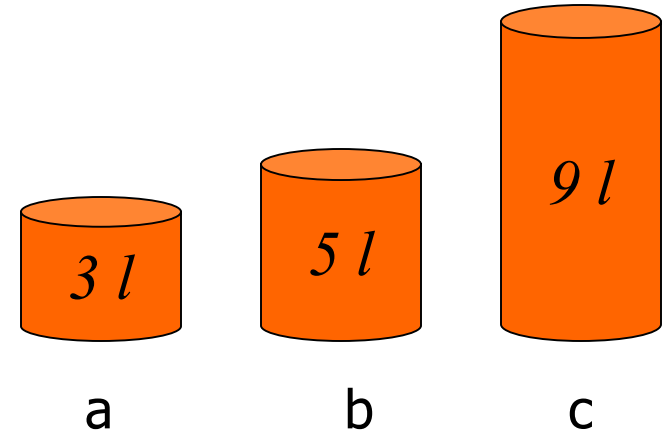

Example: Measuring problem!

- **Another Solution:**

a	b	c	
0	0	0	start
0	5	0	
3	2	0	

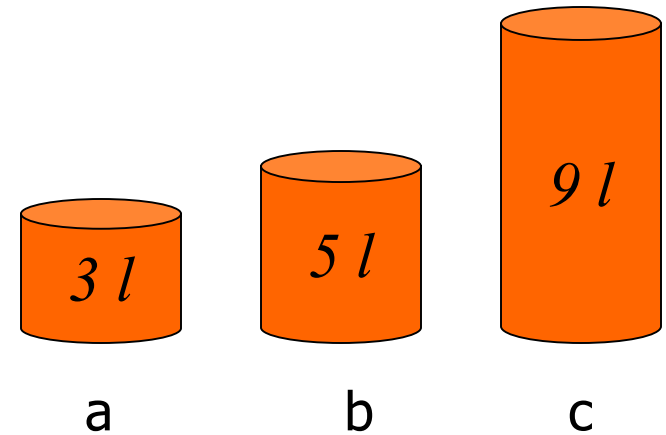

Example: Measuring problem!

- **Another Solution:**

a	b	c	
0	0	0	start
0	5	0	
3	2	0	
3	0	2	

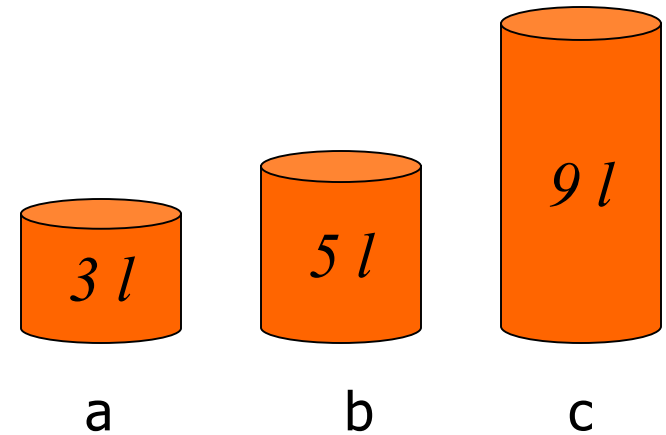

Example: Measuring problem!

- **Another Solution:**

a	b	c	
0	0	0	start
0	5	0	
3	2	0	
3	0	2	
3	5	2	

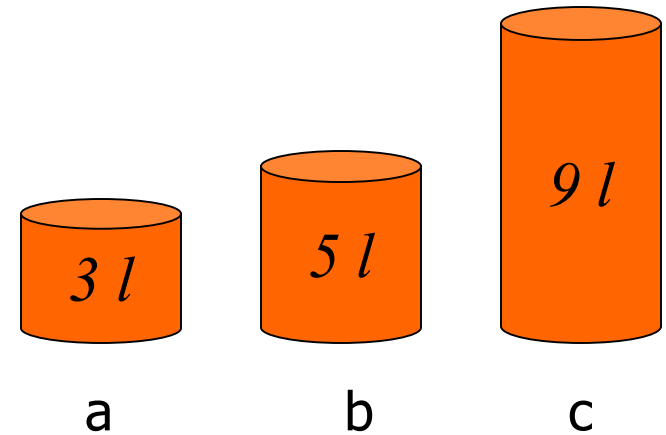

Example: Measuring problem!

- **Another Solution:**

a	b	c	
0	0	0	start
0	5	0	
3	2	0	
3	0	2	
3	5	2	
3	0	7	goal

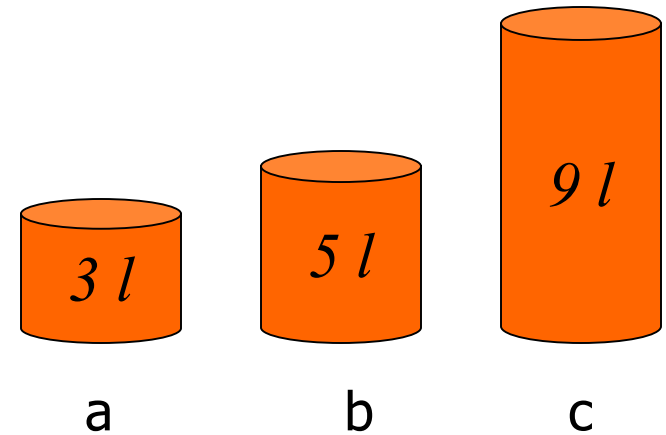

Which solution do we prefer?

- Solution 1:**

a	b	c	
0	0	0	start
3	0	0	
0	0	3	
3	0	3	
0	0	6	
3	0	6	
0	3	6	
3	3	6	
1	5	6	
0	5	7	goal

- Solution 2:**

a	b	c	
0	0	0	start
0	5	0	
3	2	0	
3	0	2	
3	5	2	
3	0	7	goal

Problem-Solving Agent

```
function SIMPLE-PROBLEM-SOLVING-AGENT(p) returns an action
inputs: p, a percept
static: s, an action sequence, initially empty
         state, some description of the current world state
         g, a goal, initially null
         problem, a problem formulation

state ← UPDATE-STATE(state, p) // What is the current state?
if s is empty then
    g ← FORMULATE-GOAL(state) // From LA to San Diego (given curr. state)
    problem ← FORMULATE-PROBLEM(state, g) // e.g., Gas usage
    s ← SEARCH(problem)
action ← RECOMMENDATION(s, state)
s ← REMAINDER(s, state) // If fails to reach goal, update
return action
```

Note: This is *offline* problem-solving. *Online* problem-solving involves acting w/o complete knowledge of the problem and environment

Example: Buckets



Measure 7 liters of water using a 3-liter, a 5-liter, and a 9-liter buckets.

- **Formulate goal:** Have 7 liters of water in 9-liter bucket
- **Formulate problem:**
 - States: amount of water in the buckets
 - Operators: Fill bucket from source, empty bucket
- **Find solution:** sequence of operators that bring you from current state to the goal state

Remember (lecture 2): Environment types

Environment	Accessible	Deterministic	Episodic	Static	Discrete
Operating System	Yes	Yes	No	No	Yes
Virtual Reality	Yes	Yes	Yes/No	No	Yes/No
Office Environment	No	No	No	No	No
Mars	No	Semi	No	Semi	No

The environment types largely determine the agent design.

Problem types



- **Single-state problem:** deterministic, accessible
Agent knows everything about world, thus can calculate optimal action sequence to reach goal state.
- **Multiple-state problem:** deterministic, inaccessible
Agent must reason about sequences of actions and states assumed while working towards goal state.
- **Contingency problem:** nondeterministic, inaccessible
 - *Must use sensors during execution*
 - *Solution is a tree or policy*
 - *Often interleave search and execution*
- **Exploration problem:** unknown state space
Discover and learn about environment while taking actions.

Problem types



- **Single-state problem:** deterministic, accessible
 - Agent knows everything about world (the exact state),
 - Can calculate optimal action sequence to reach goal state.
- E.g., playing chess. Any action will result in an exact state

Problem types



- **Multiple-state problem:** deterministic, inaccessible
 - Agent does not know the exact state (could be in any of the possible states)
 - May not have sensor at all
 - Assume states while working towards goal state.
- E.g., walking in a dark room
 - If you are at the door, going straight will lead you to the kitchen
 - If you are at the kitchen, turning left leads you to the bedroom
 - ...

Problem types



- **Contingency problem:** nondeterministic, inaccessible
 - Must use sensors during execution
 - Solution is a tree or policy
 - Often interleave search and execution

- E.g., a new skater in an arena
 - Sliding problem.
 - Many skaters around

Problem types



- **Exploration problem:** unknown state space

Discover and learn about environment while taking actions.

- *E.g., Maze*

Example: Vacuum world

Simplified world: 2 locations, each may or not contain dirt, each may or not contain vacuuming agent.

Goal of agent: clean up the dirt.

Single-state, start in #5. Solution??

Multiple-state, start in $\{1, 2, 3, 4, 5, 6, 7, 8\}$
e.g., *Right* goes to $\{2, 4, 6, 8\}$. Solution??

Contingency, start in #5

Murphy's Law: *Suck* can dirty a clean carpet

Local sensing: dirt, location only.

Solution??

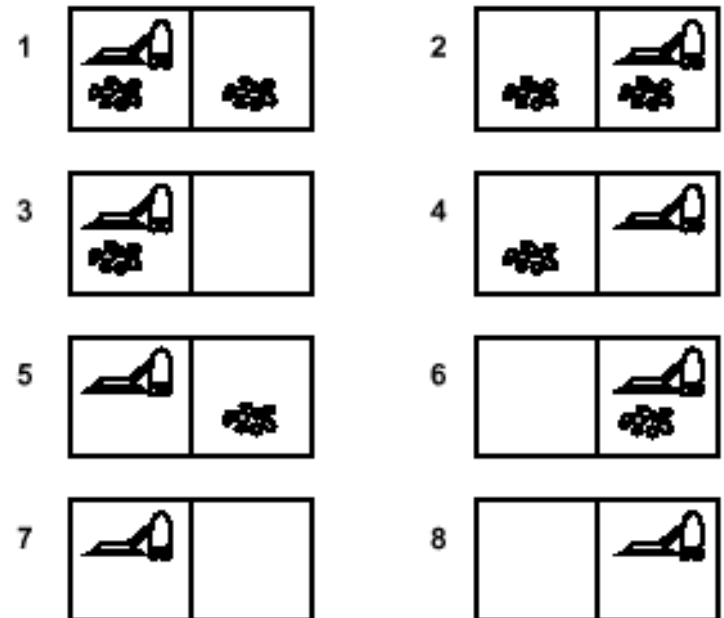







Example: Romania



- In Romania, on vacation. Currently in Arad.
- Flight leaves tomorrow from Bucharest.
- **Formulate goal:**
 - be in Bucharest
- **Formulate problem:**
 - states: various cities
 - operators: drive between cities
- **Find solution:**
 - sequence of cities, such that total driving distance is minimized.

Example: Traveling from Arad To Bucharest

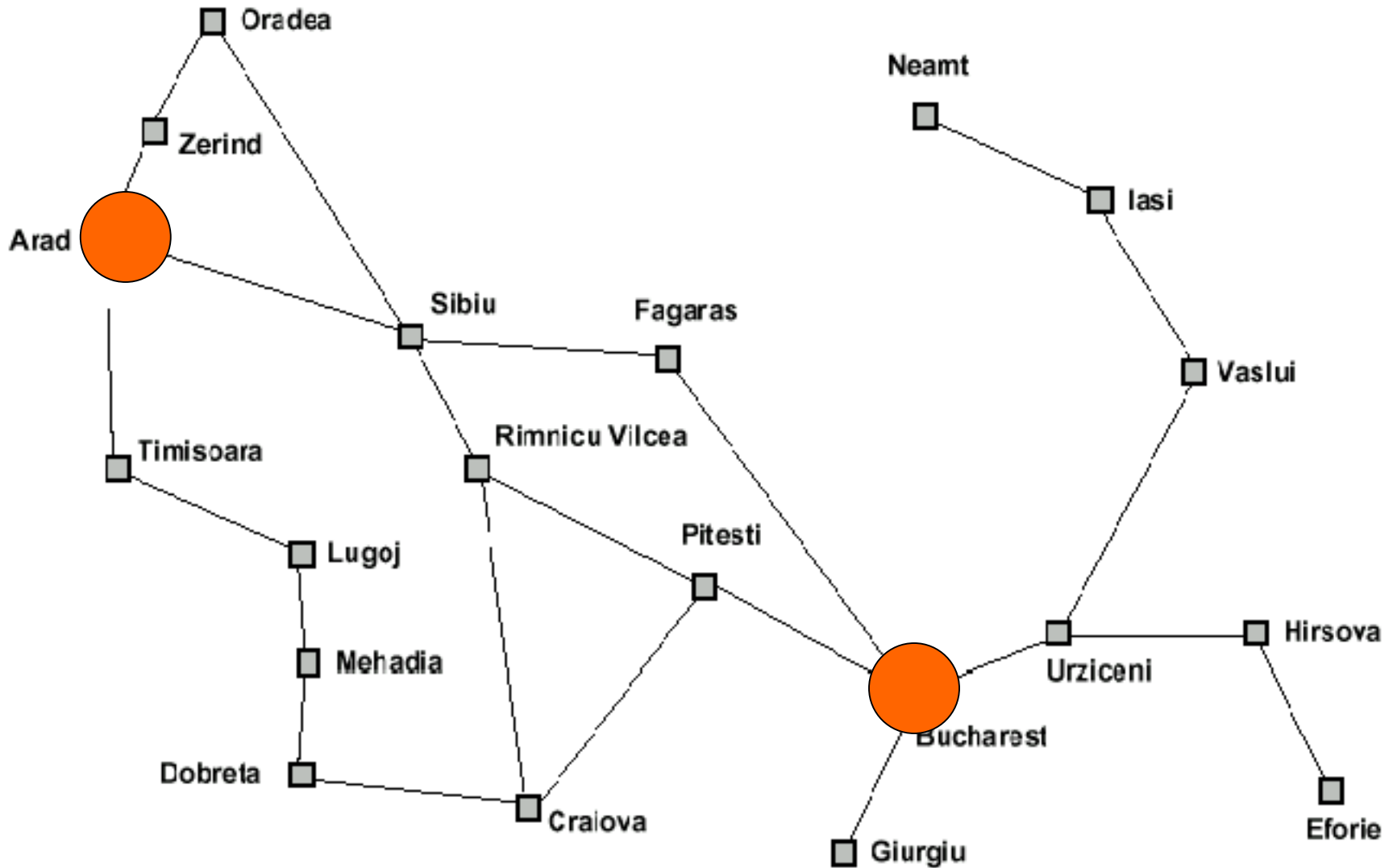

Problem formulation

A *problem* is defined by four items:

initial state e.g., “at Arad”

operators (or *successor function* $S(x)$)

e.g., Arad \rightarrow Zerind Arad \rightarrow Sibiu etc.

goal test, can be

explicit, e.g., $x =$ “at Bucharest”

implicit, e.g., $NoDirt(x)$

path cost (additive)

e.g., sum of distances, number of operators executed, etc.

A *solution* is a sequence of operators
leading from the initial state to a goal state

Selecting a state space



- Real world is absurdly complex; some abstraction is necessary to allow us to reason on it...
- Selecting the correct abstraction and resulting state space is a difficult problem!
- Abstract states \Leftrightarrow real-world states
- Abstract operators \Leftrightarrow sequences or real-world actions
(e.g., going from city i to city j costs L_{ij} \Leftrightarrow actually drive from city i to j)
- Abstract solution \Leftrightarrow set of real actions to take in the real world such as to solve problem

Example: 8-puzzle

5	4	
6	1	8
7	3	2

start state

1	2	3
8		4
7	6	5

goal state

- State:
- Operators:
- Goal test:
- Path cost:

Example: 8-puzzle

5	4	
6	1	8
7	3	2

start state

1	2	3
8		4
7	6	5

goal state

- State: integer location of tiles (ignore intermediate locations)
- Operators: moving blank left, right, up, down (ignore jamming)
- Goal test: does state match goal state?
- Path cost: 1 per move

Example: 8-puzzle

5	4	
6	1	8
7	3	2

start state

1	2	3
8		4
7	6	5

goal state

Why search algorithms?

- 8-puzzle has 362,800 states
- 15-puzzle has 10^{12} states
- 24-puzzle has 10^{25} states

So, we need a principled way to look for a solution in these huge search spaces...

Back to Vacuum World

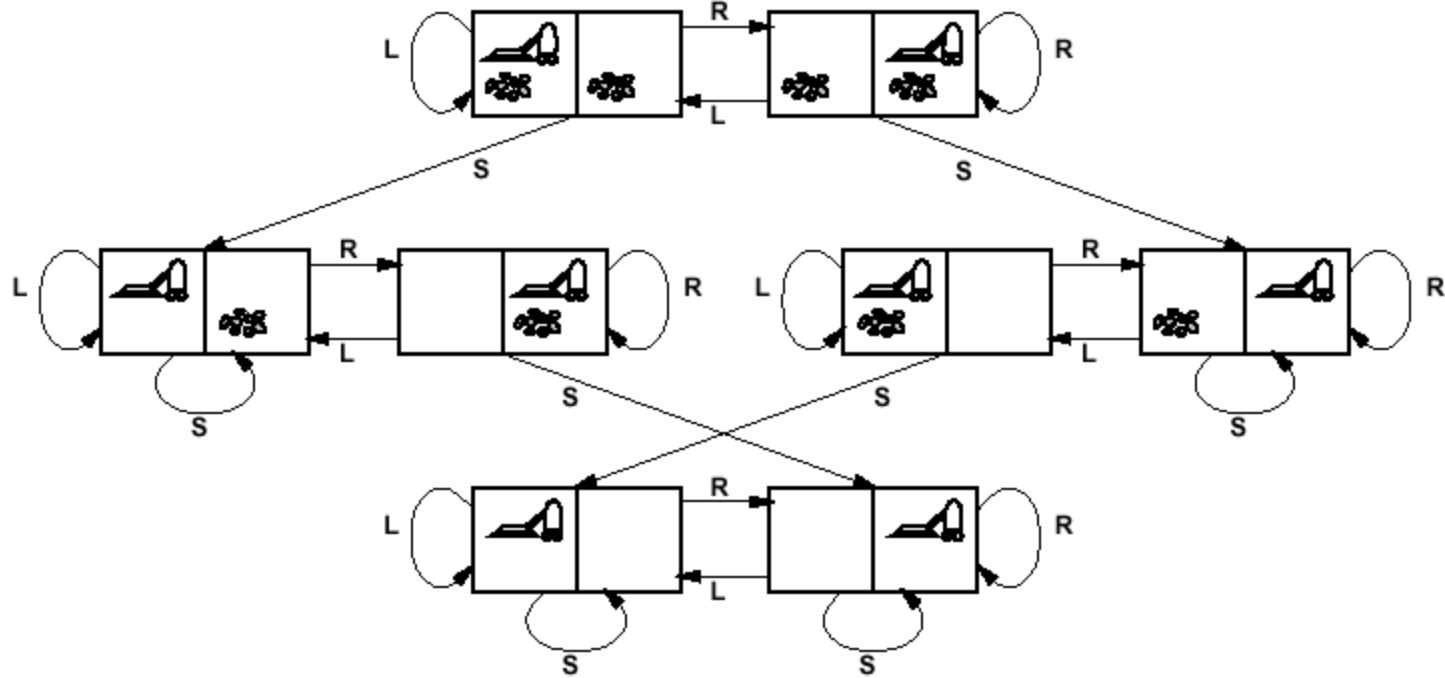

states??

operators??

goal test??

path cost??

Back to Vacuum World

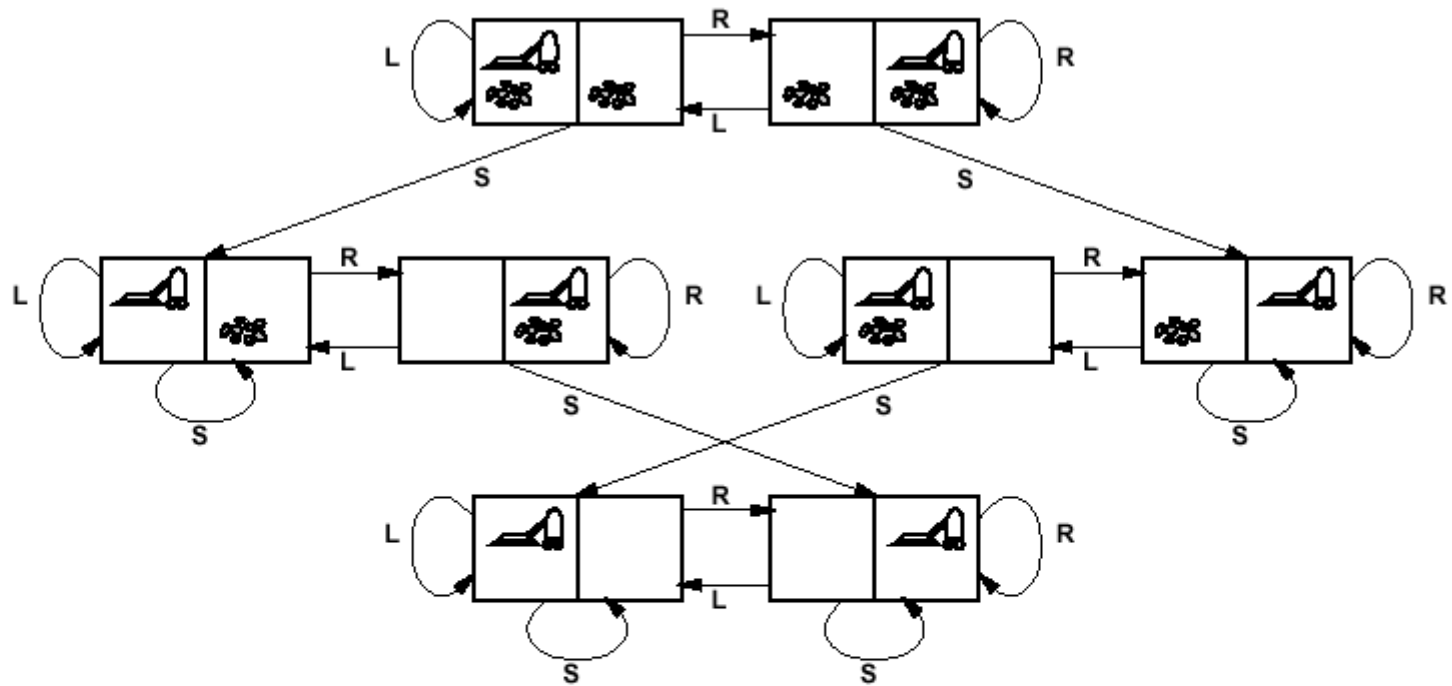

states?: integer dirt and robot locations (ignore dirt *amounts*)

operators?: *Left, Right, Suck*

goal test?: no dirt

path cost?: 1 per operator

Example: Robotic Assembly

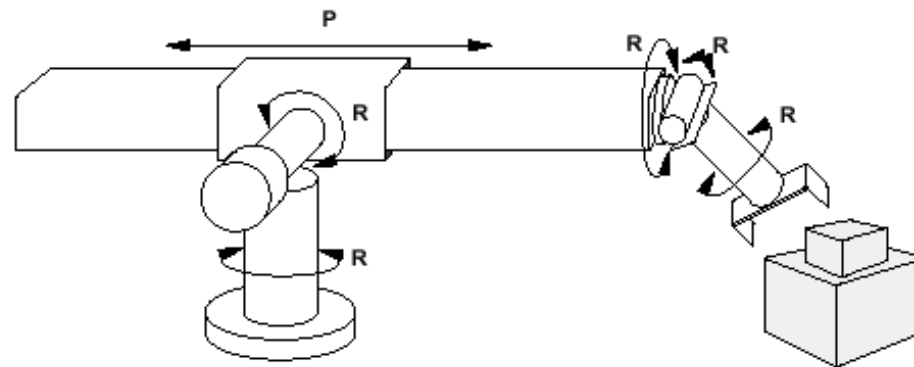

states??: real-valued coordinates of
robot joint angles
parts of the object to be assembled

operators??: continuous motions of robot joints

goal test??: complete assembly *with no robot included!*

path cost??: time to execute

Real-life example: VLSI Layout



- Given schematic diagram comprising components (chips, resistors, capacitors, etc) and interconnections (wires), find optimal way to place components on a printed circuit board, under the constraint that only a small number of wire layers are available (and wires on a given layer cannot cross!)
- “optimal way”??
 - minimize surface area
 - minimize number of signal layers
 - minimize number of vias (connections from one layer to another)
 - minimize length of some signal lines (e.g., clock line)
 - distribute heat throughout board
 - etc.

Enter schematics;

do not worry about placement & wire crossing

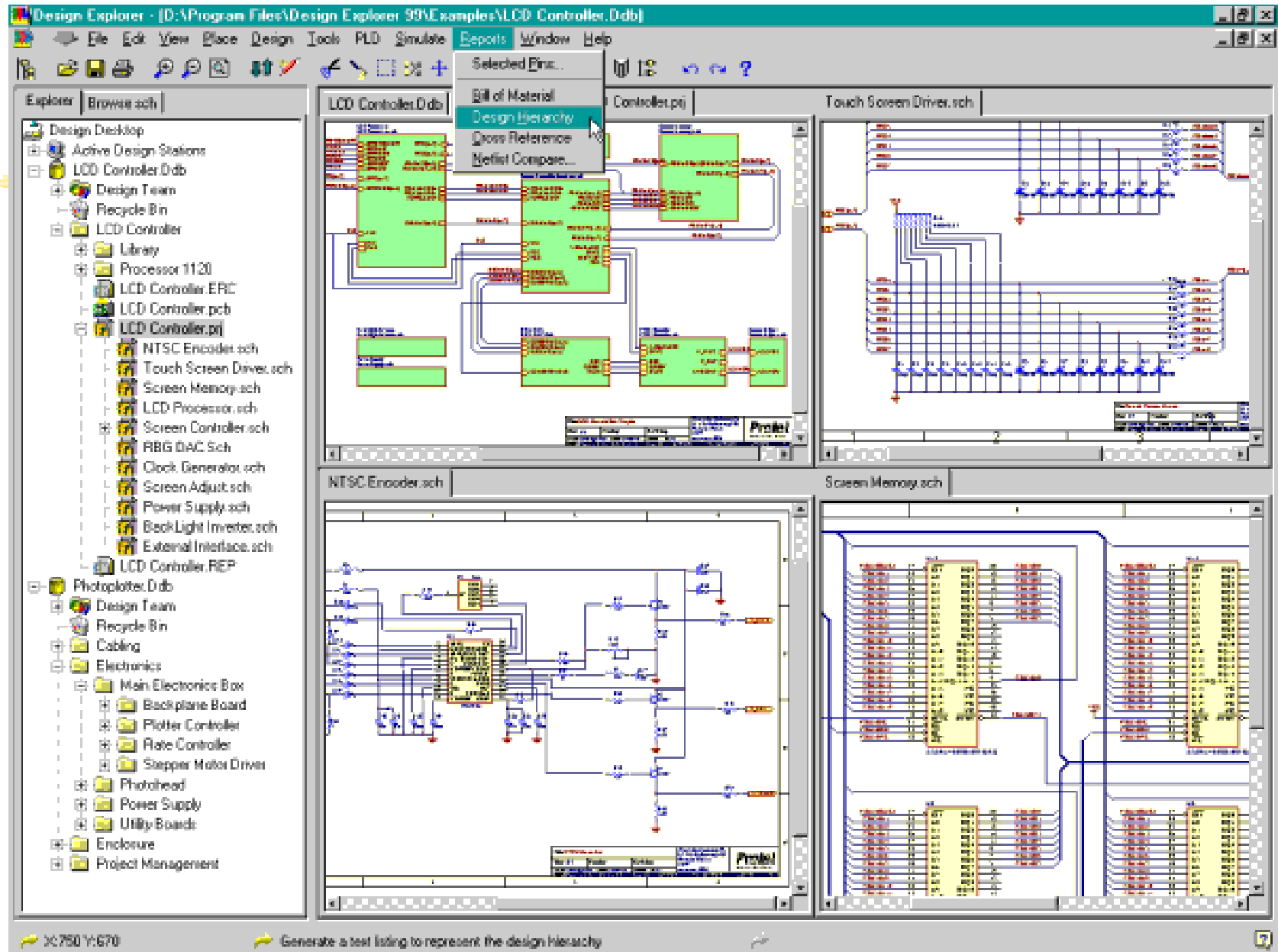

Protel's hierarchical schematic design features let you take a "bottom up" or "top down" approach, depending on your preferred methodology. Protel can automatically generate sub-sheets based on higher-level sheet symbols, or create sheet symbols based on existing sheets.

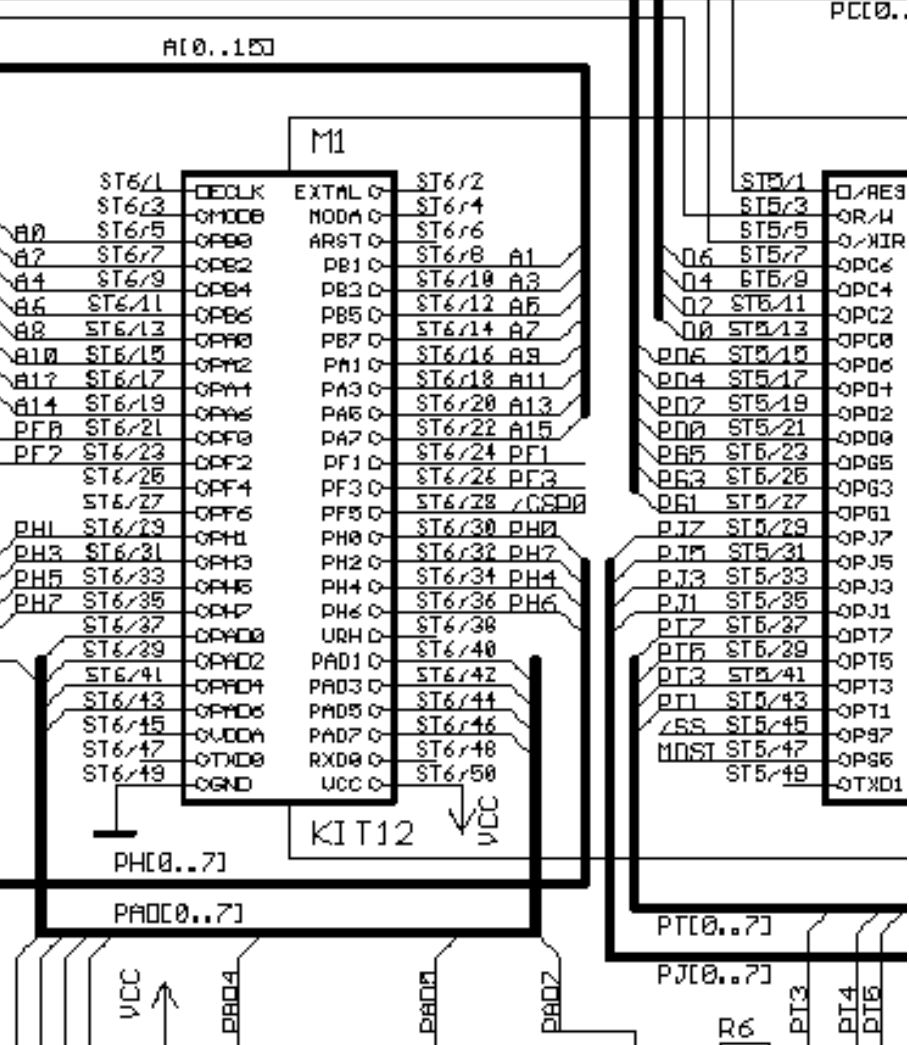
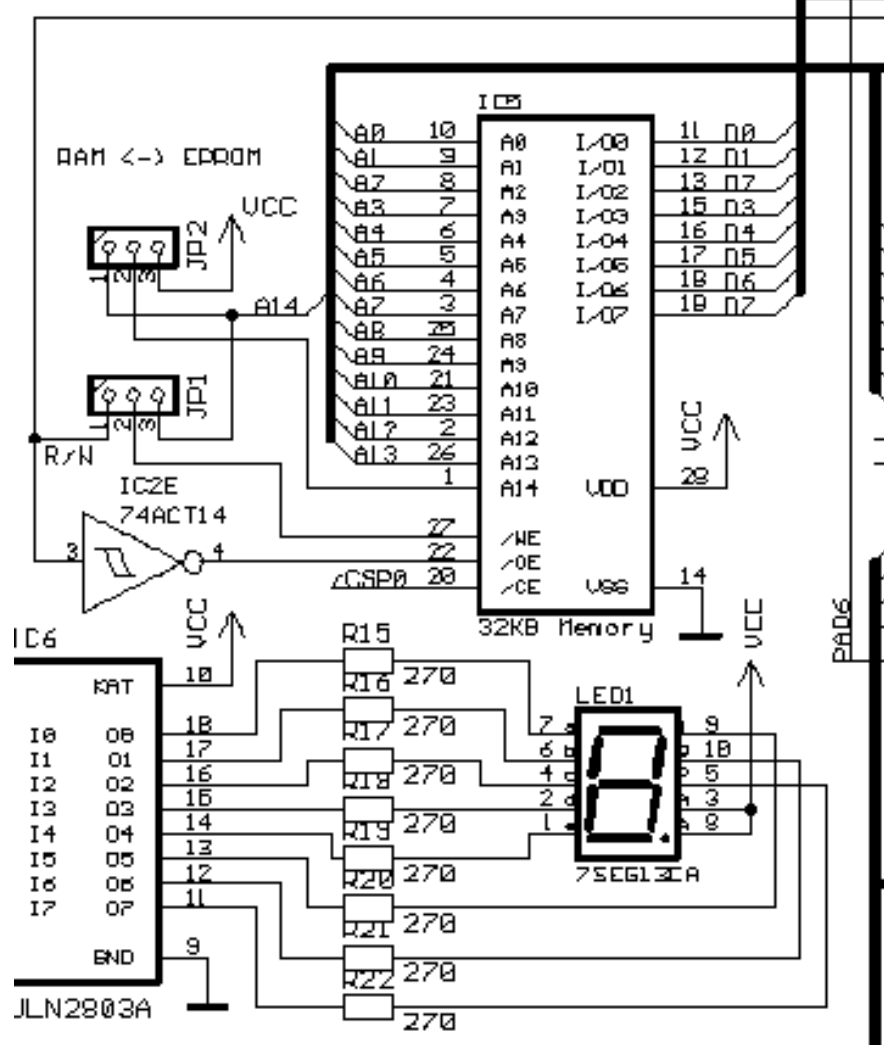
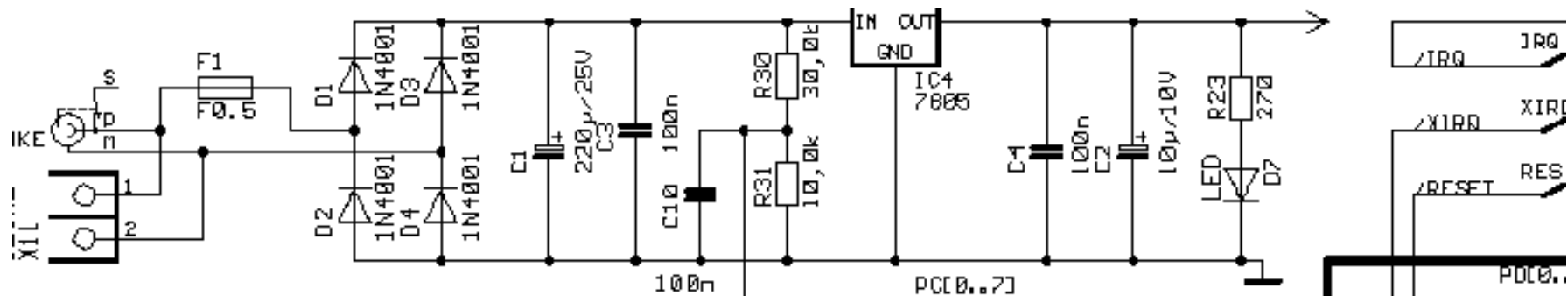

Use automated tools to place components and route wiring.

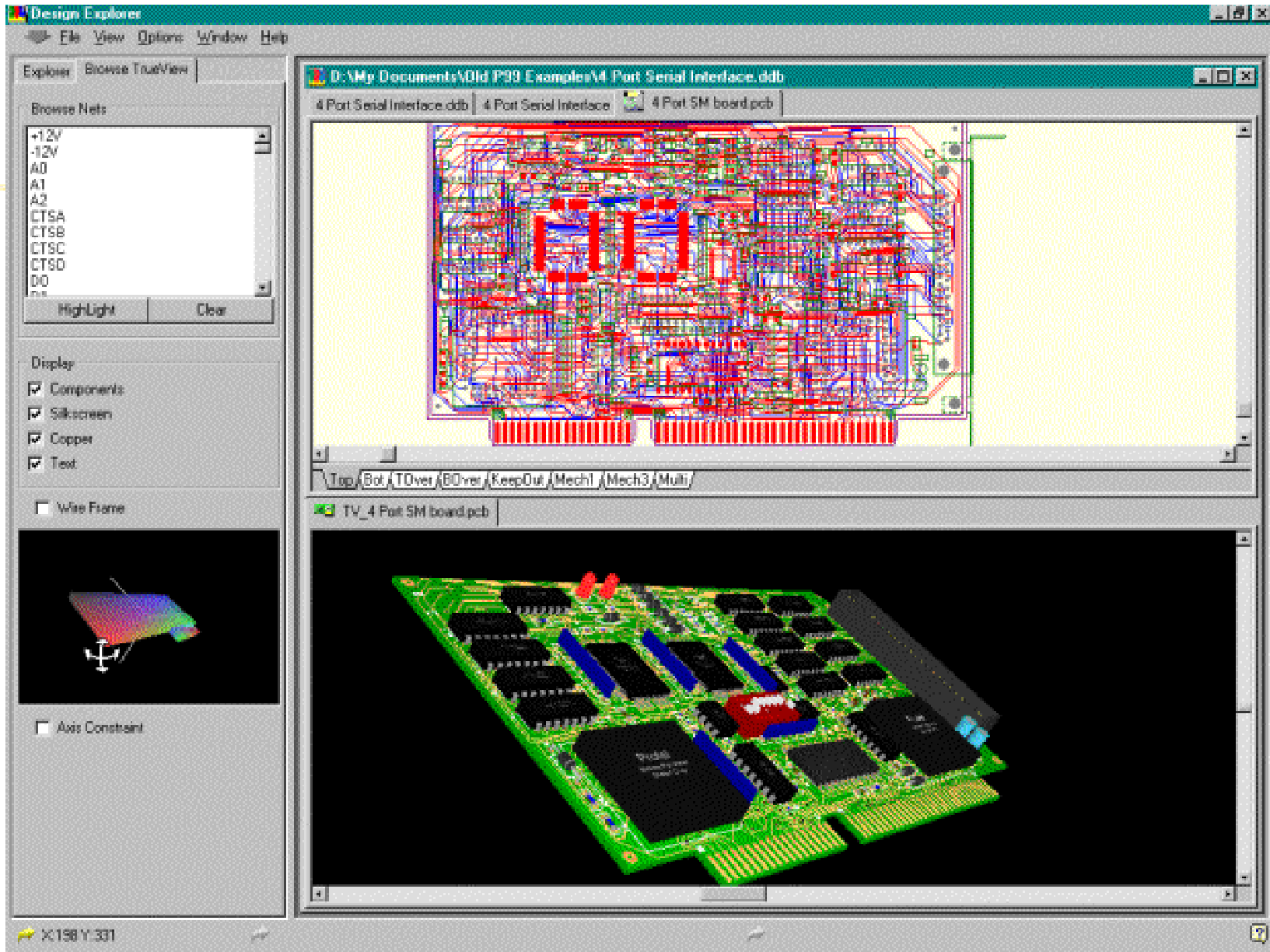

Protel 99 SE's unique 3D visualization feature lets you see your finished board before it leaves your desktop. Sophisticated 3D modeling and extrusion techniques render your board in stunning 3D without the need for additional height information. Rotate and zoom to examine every aspect of your board.

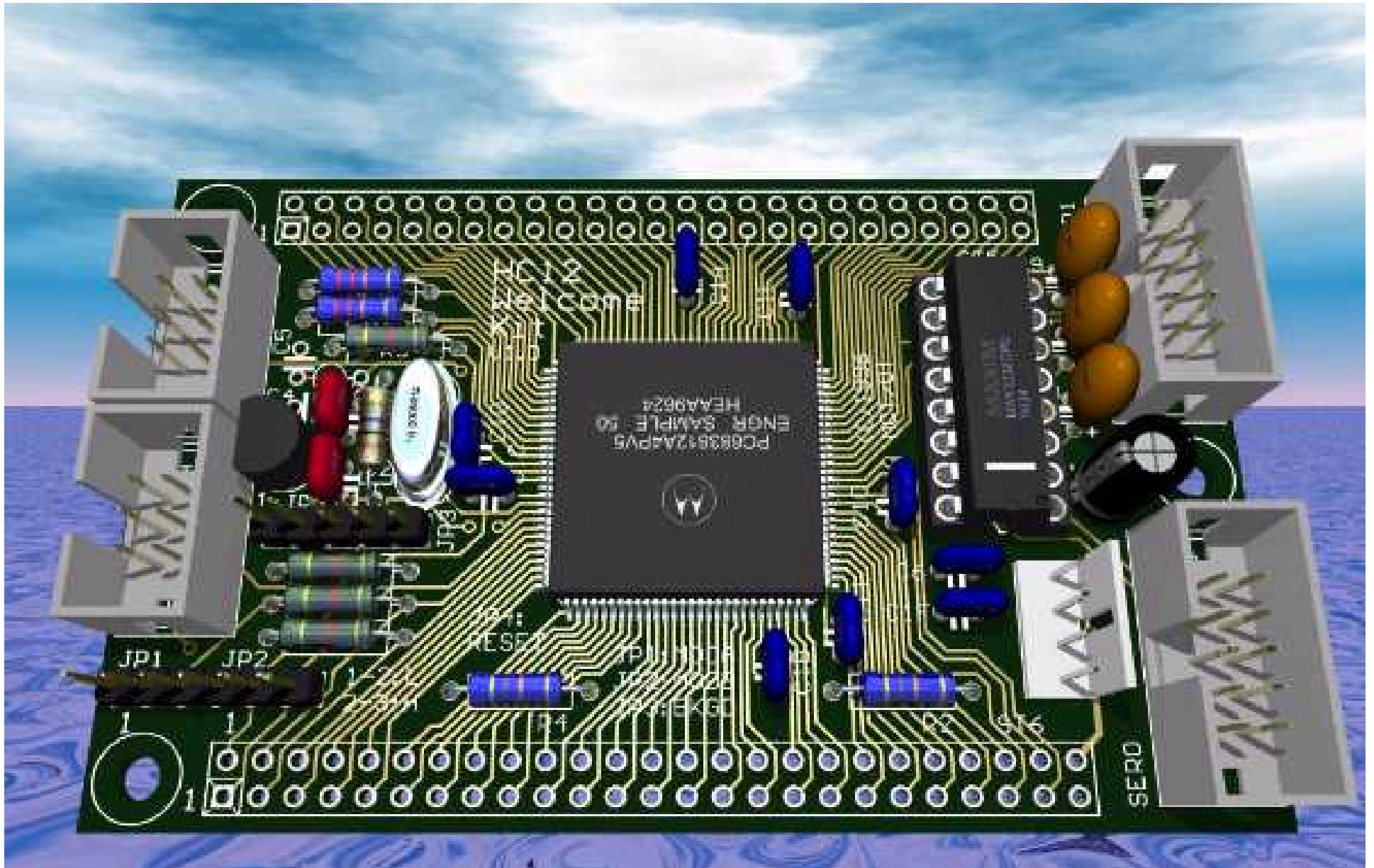

Search algorithms



Basic idea:

offline, systematic exploration of simulated state-space by generating successors of explored states (expanding)

```
Function General-Search(problem, strategy) returns a solution, or failure
  initialize the search tree using the initial state problem
  loop do
    if there are no candidates for expansion then return failure
    choose a leaf node for expansion according to strategy
    if the node contains a goal state then
      return the corresponding solution
    else expand the node and add resulting nodes to the search tree
  end
```

Last time: Problem-Solving



- **Problem solving:**
 - Goal formulation
 - Problem formulation (states, operators)
 - Search for solution

- **Problem formulation:**
 - Initial state
 - ?
 - ?
 - ?

- **Problem types:**
 - single state: accessible and deterministic environment
 - multiple state: ?
 - contingency: ?
 - exploration: ?

Last time: Problem-Solving



- **Problem solving:**
 - Goal formulation
 - Problem formulation (states, operators)
 - Search for solution
- **Problem formulation:**
 - Initial state
 - Operators
 - Goal test
 - Path cost
- **Problem types:**
 - single state: accessible and deterministic environment
 - multiple state: ?
 - contingency: ?
 - exploration: ?

Last time: Problem-Solving



- **Problem solving:**
 - Goal formulation
 - Problem formulation (states, operators)
 - Search for solution
- **Problem formulation:**
 - Initial state
 - Operators
 - Goal test
 - Path cost
- **Problem types:**
 - single state: accessible and deterministic environment
 - multiple state: inaccessible and deterministic environment
 - contingency: inaccessible and nondeterministic environment
 - exploration: unknown state-space

Last time: Finding a solution



Solution: is ???

Basic idea: offline, systematic exploration of simulated state-space by generating successors of explored states (expanding)

```
Function General-Search(problem, strategy) returns a solution, or failure
  initialize the search tree using the initial state problem
  loop do
    if there are no candidates for expansion then return failure
    choose a leaf node for expansion according to strategy
    if the node contains a goal state then return the corresponding solution
    else expand the node and add resulting nodes to the search tree
  end
```

Last time: Finding a solution

Solution: is a sequence of operators that bring you from current state to the goal state.

Basic idea: offline, systematic exploration of simulated state-space by generating successors of explored states (expanding).

```
Function General-Search(problem, strategy) returns a solution, or failure
  initialize the search tree using the initial state problem
  loop do
    if there are no candidates for expansion then return failure
    choose a leaf node for expansion according to strategy
    if the node contains a goal state then return the corresponding solution
    else expand the node and add resulting nodes to the search tree
  end
```

Strategy: The search strategy is determined by ???

Last time: Finding a solution

Solution: is a sequence of operators that bring you from current state to the goal state

Basic idea: offline, systematic exploration of simulated state-space by generating successors of explored states (expanding)

```
Function General-Search(problem, strategy) returns a solution, or failure
  initialize the search tree using the initial state problem
  loop do
    if there are no candidates for expansion then return failure
    choose a leaf node for expansion according to strategy
    if the node contains a goal state then return the corresponding solution
    else expand the node and add resulting nodes to the search tree
  end
```

Strategy: The search strategy is determined by the order in which the nodes are expanded.

Example: Traveling from Arad To Bucharest

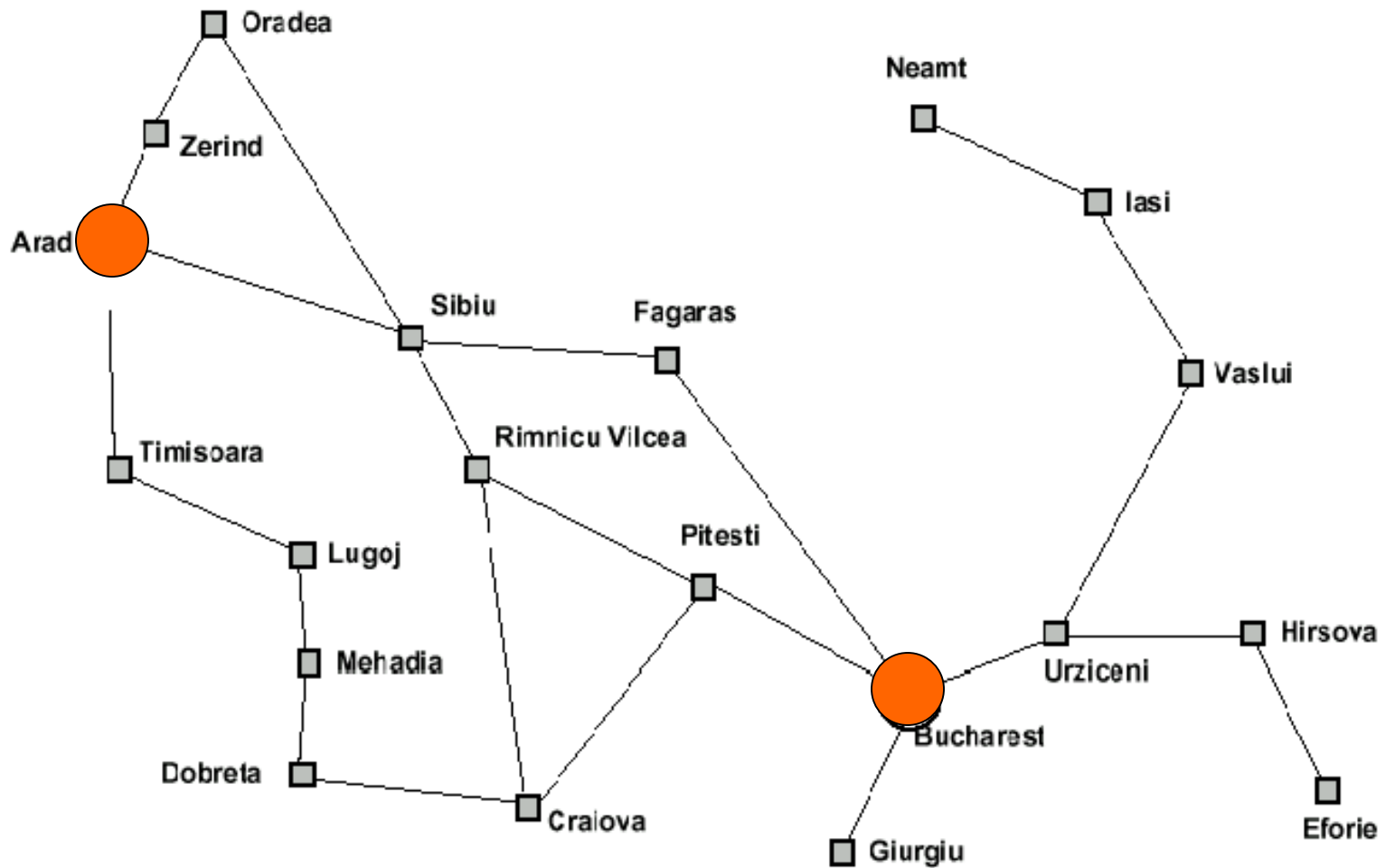

From problem space to search tree

- Some material in this and following slides is from

<http://www.cs.kuleuven.ac.be/~dannyd/FAI/>

check it out!

Problem space

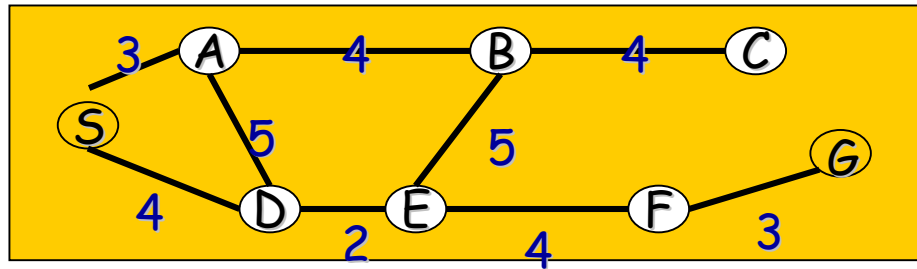

Associated loop-free search tree

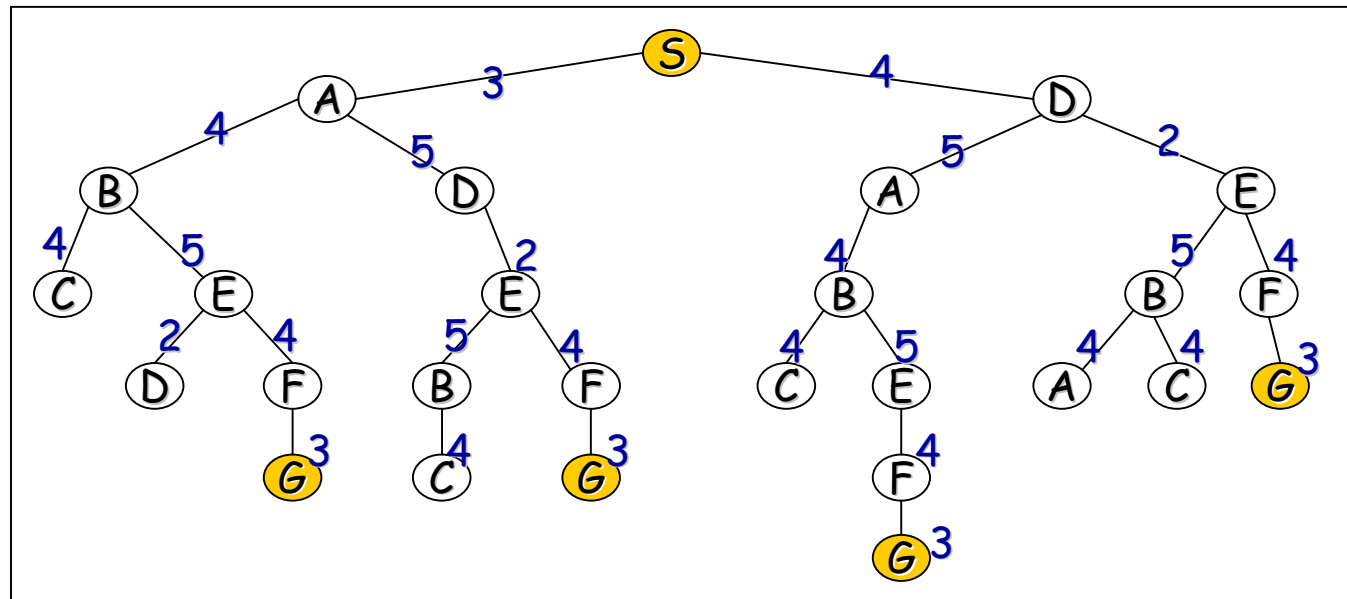

Paths in search trees

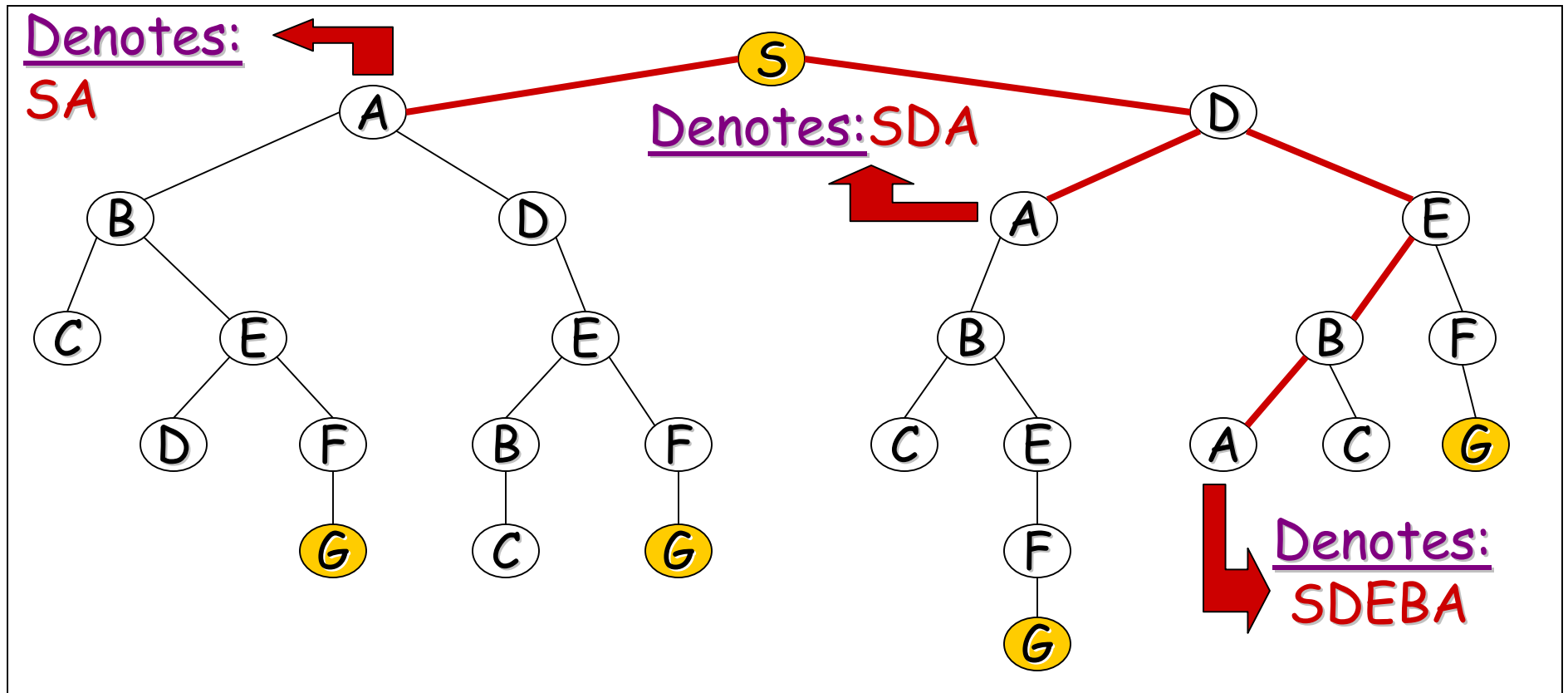

General search example



General search example

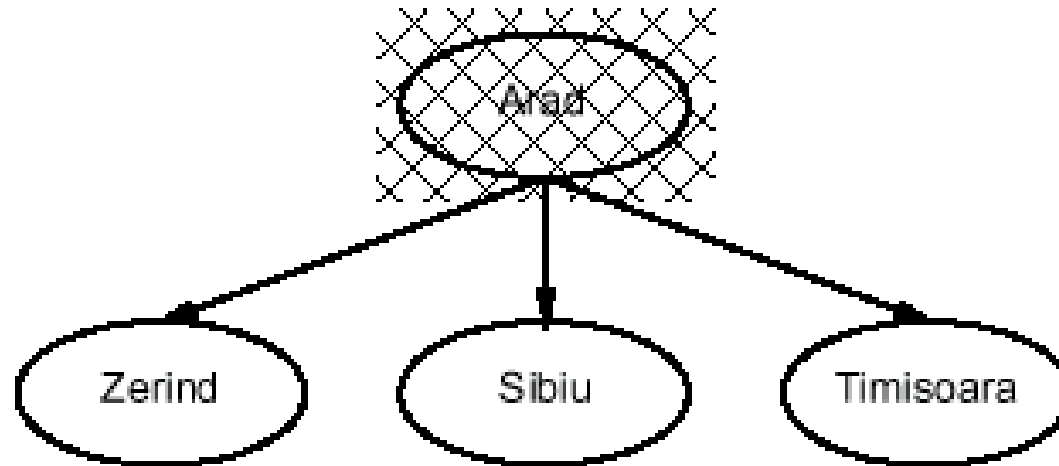

General search example

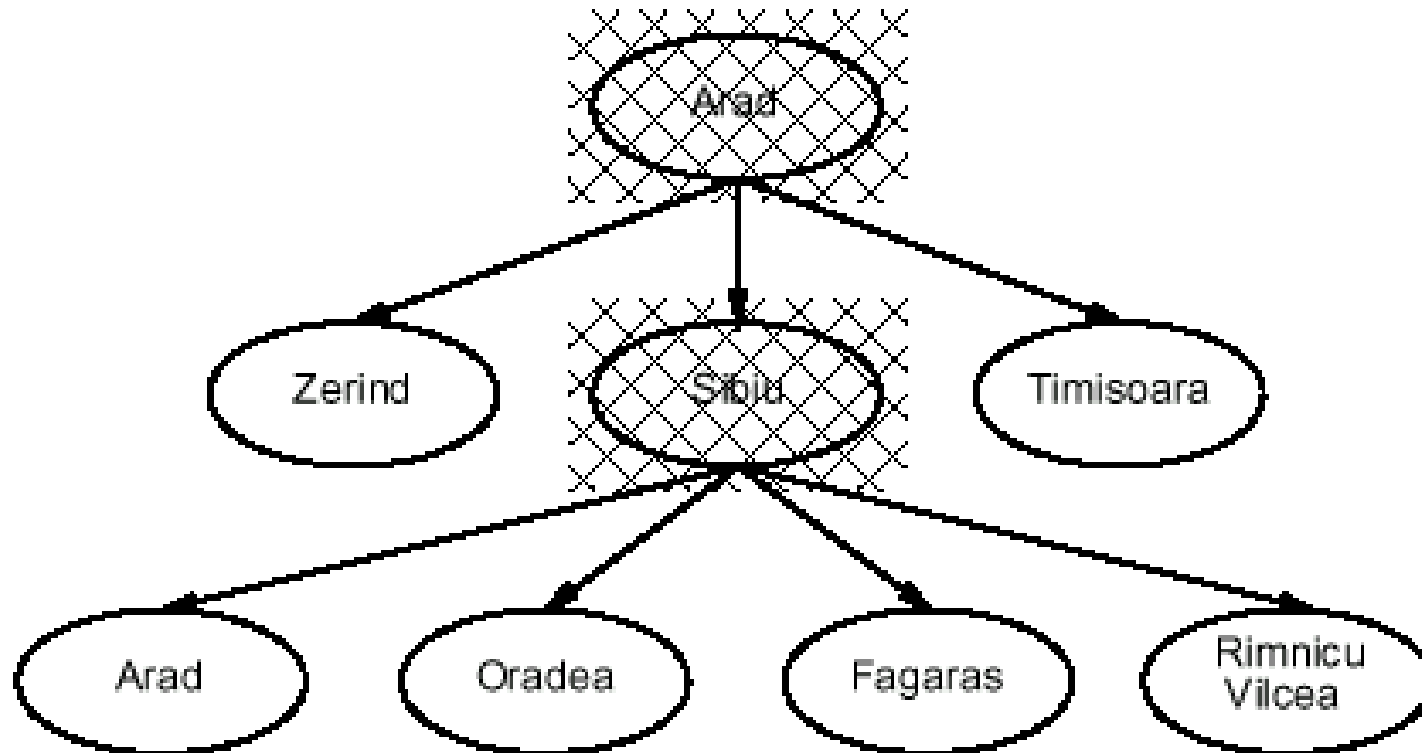

General search example

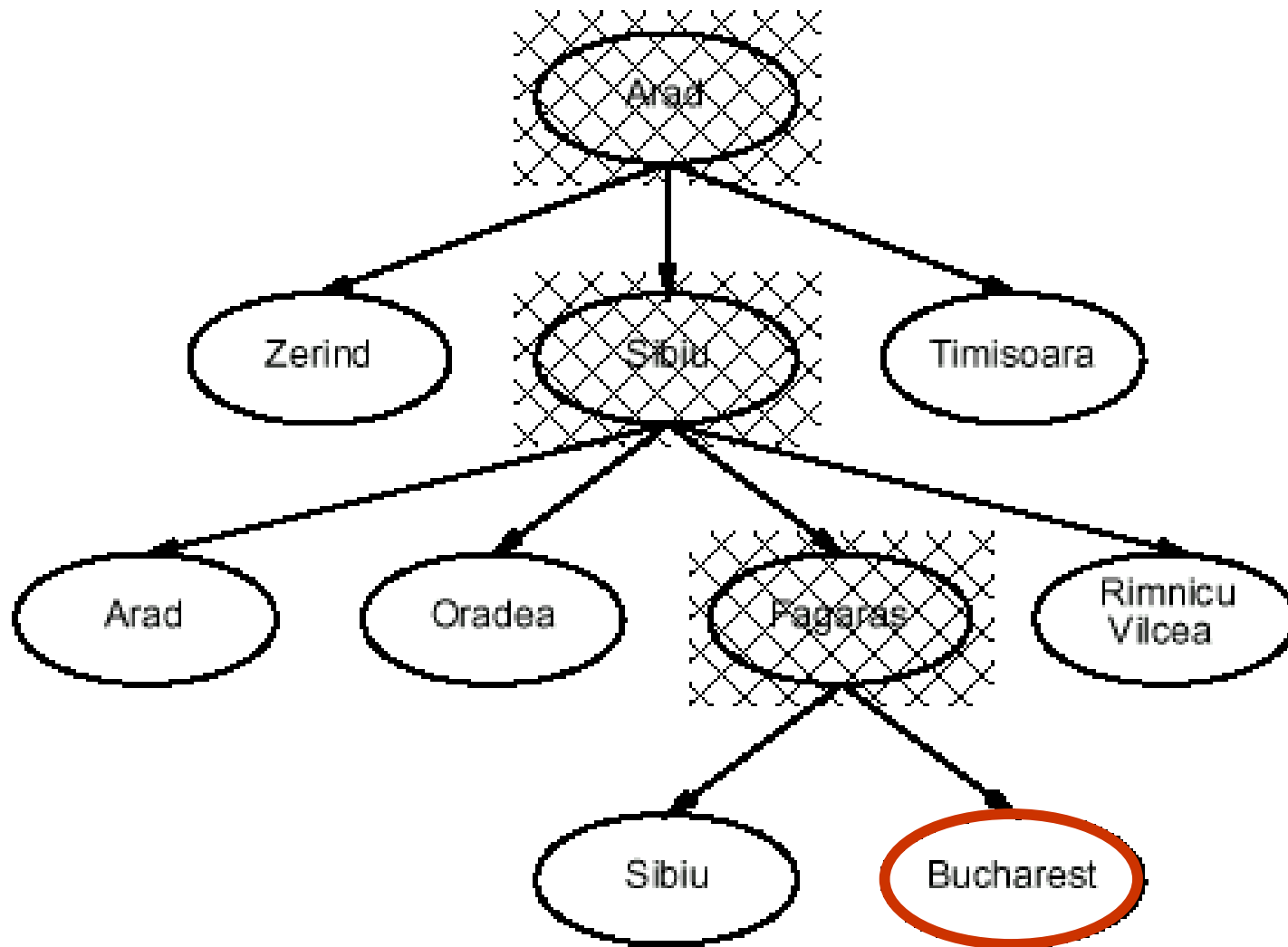

Implementation of search algorithms

```
Function General-Search(problem, Queuing-Fn) returns a solution, or failure
nodes ← make-queue(make-node(initial-state[problem]))
loop do
  if nodes is empty then return failure
  node ← Remove-Front(nodes)
  if Goal-Test[problem] applied to State(node) succeeds then return node
  nodes ← Queuing-Fn(nodes, Expand(node, Operators[problem]))
end
```

Queuing-Fn(*queue*, *elements*) is a queuing function that inserts a set of elements into the queue and determines the order of node expansion. Varieties of the queuing function produce varieties of the search algorithm.

Encapsulating *state* information in *nodes*

A *state* is a (representation of) a physical configuration

A *node* is a data structure constituting part of a search tree

includes *parent*, *children*, *depth*, *path cost* $g(x)$

States do not have parents, children, depth, or path cost!

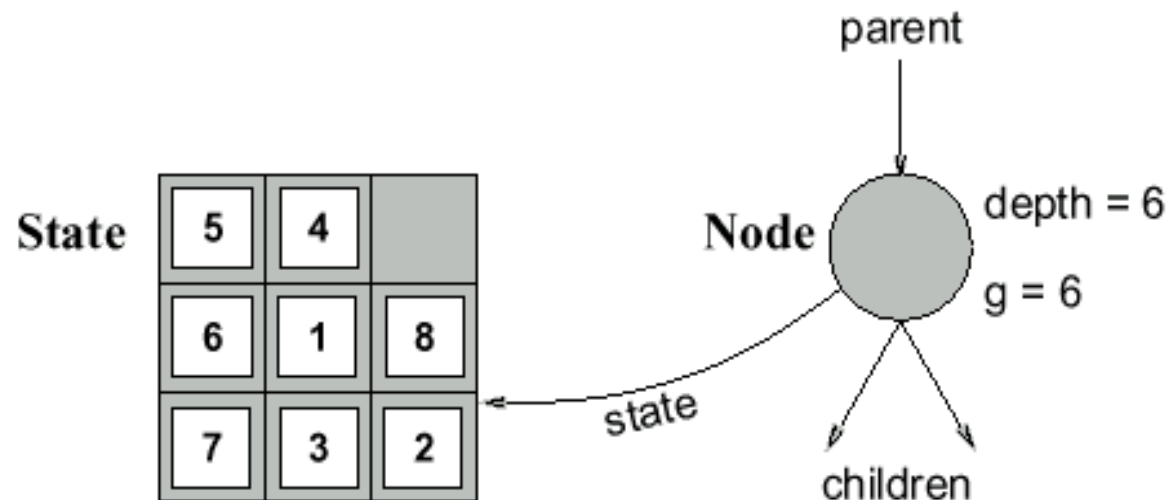

The EXPAND function creates new nodes, filling in the various fields and using the OPERATORS (or SUCCESSORFN) of the problem to create the corresponding states.

Evaluation of search strategies



- A search strategy is defined by **picking the order of node expansion.**
- Search algorithms are commonly evaluated according to the following four criteria:
 - **Completeness:** does it always find a solution if one exists?
 - **Time complexity:** how long does it take as function of num. of nodes?
 - **Space complexity:** how much memory does it require?
 - **Optimality:** does it guarantee the least-cost solution?
- Time and space complexity are measured in terms of:
 - b – max branching factor of the search tree
 - d – depth of the least-cost solution
 - m – max depth of the search tree (may be infinity)

Binary Tree Example

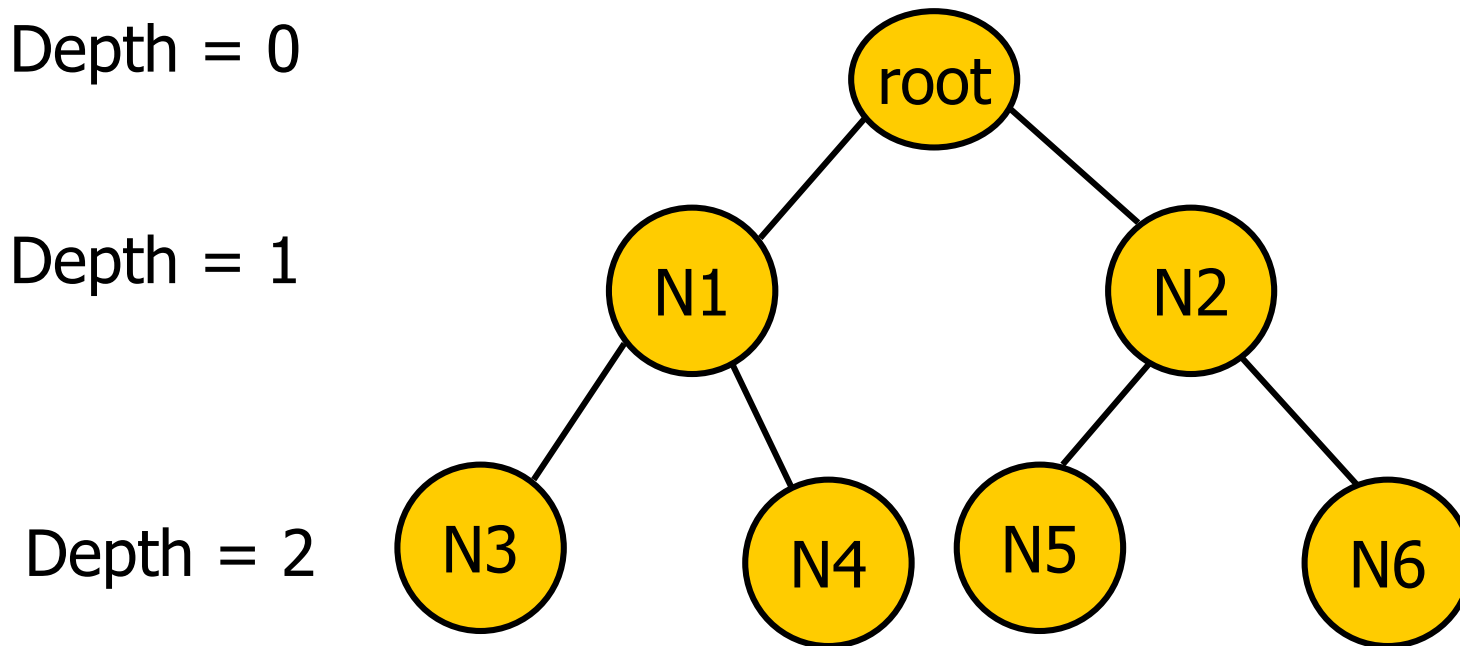

Number of nodes: $n = 2^{\text{max depth}}$

Number of levels (max depth) = $\log(n)$ (could be n)

Complexity



- Why worry about complexity of algorithms?
 - because a problem may be solvable in principle but may take too long to solve in practice

Complexity: Tower of Hanoi

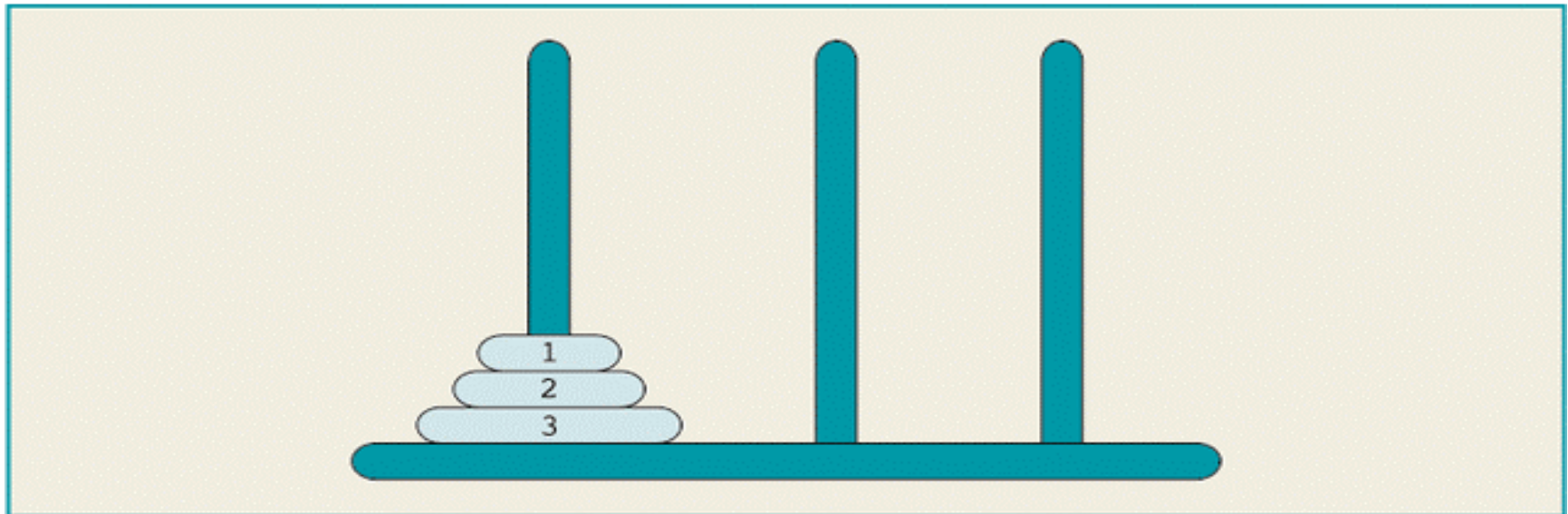

Figure 11-6 Tower of Hanoi problem with three disks

Complexity: Tower of Hanoi

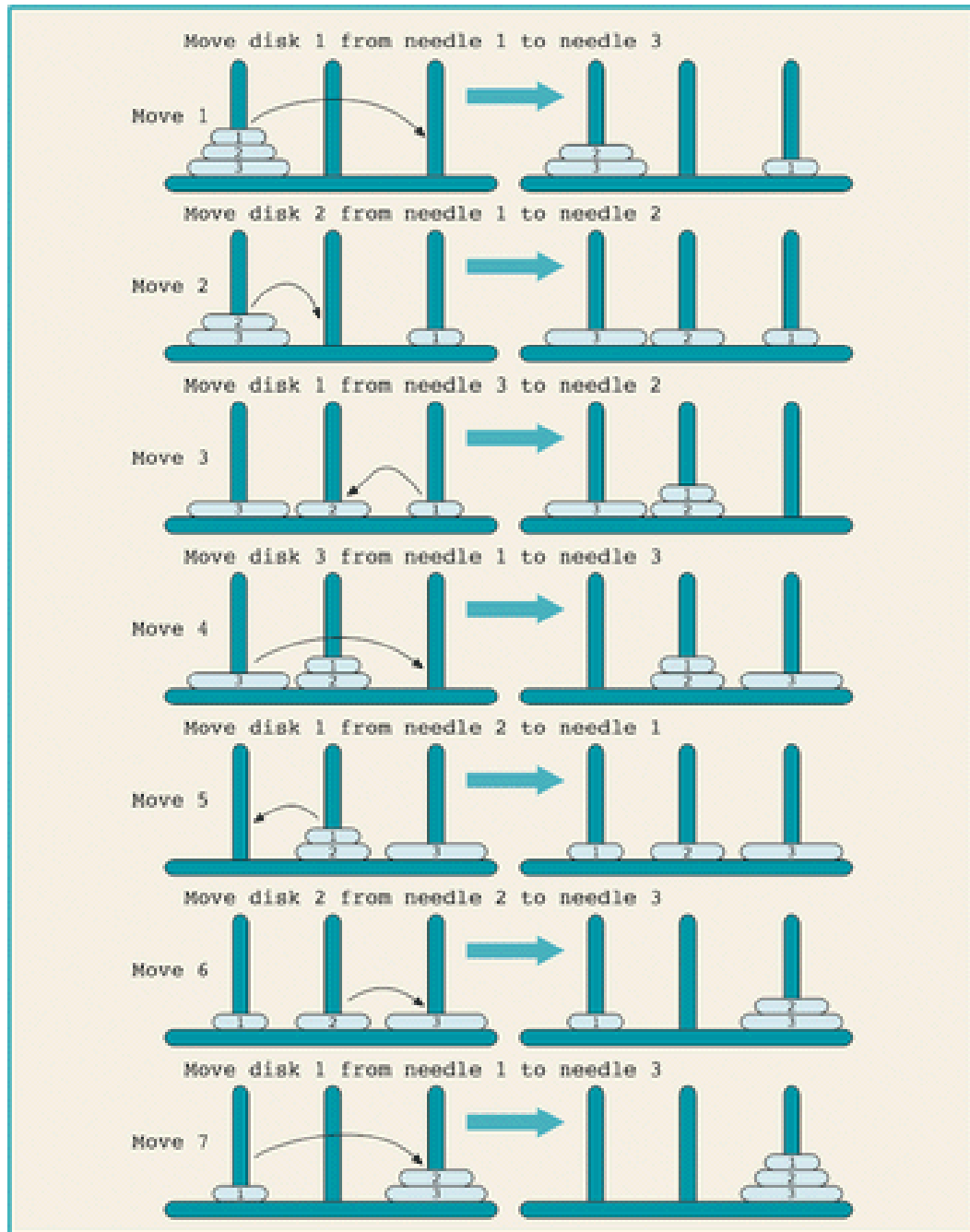

Figure 11-7 Solution of Tower of Hanoi problem with three disks

Complexity: Tower of Hanoi



- 3-disk problem: $2^3 - 1 = 7$ moves
- 64-disk problem: $2^{64} - 1$.
 - $2^{10} = 1024 \approx 1000 = 10^3$,
 - $2^{64} = 2^4 * 2^{60} \approx 2^4 * 10^{18} = 1.6 * 10^{19}$
- One year $\approx 3.2 * 10^7$ seconds

Complexity: Tower of Hanoi

- The wizard's speed = one disk / second

$$1.6 * 10^{19} = 5 * 3.2 * 10^{18} =$$

$$5 * (3.2 * 10^7) * 10^{11} =$$

$$(3.2 * 10^7) * (5 * 10^{11})$$

Complexity: Tower of Hanoi

- The time required to move all 64 disks from needle 1 to needle 3 is roughly $5 * 10^{11}$ years.
- It is estimated that our universe is about 15 billion = $1.5 * 10^{10}$ years old.

$$5 * 10^{11} = 50 * 10^{10} \approx 33 * (1.5 * 10^{10}).$$

Complexity: Tower of Hanoi

- Assume: a computer with 1 billion = 10^9 moves/second.
 - $\text{Moves/year} = (3.2 * 10^7) * 10^9 = 3.2 * 10^{16}$
- To solve the problem for 64 disks:
 - $2^{64} \approx 1.6 * 10^{19} = 1.6 * 10^{16} * 10^3 =$
 $(3.2 * 10^{16}) * 500$
 - 500 years for the computer to generate 2^{64} moves at the rate of 1 billion moves per second.

Complexity



- Why worry about complexity of algorithms?
 - because a problem may be solvable in principle but may take too long to solve in practice
- How can we evaluate the complexity of algorithms?
 - through asymptotic analysis, i.e., estimate time (or number of operations) necessary to solve an instance of size n of a problem when n tends towards infinity
 - See AIMA, Appendix A.

Complexity example: Traveling Salesman Problem

- There are n cities, with a road of length L_{ij} joining city i to city j .
- The salesman wishes to find a way to visit all cities that is optimal in two ways:
each city is visited only once, and
the total route is as short as possible.

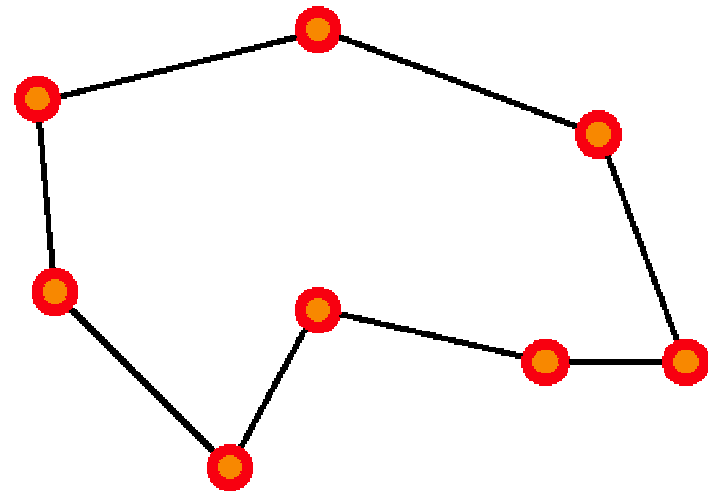
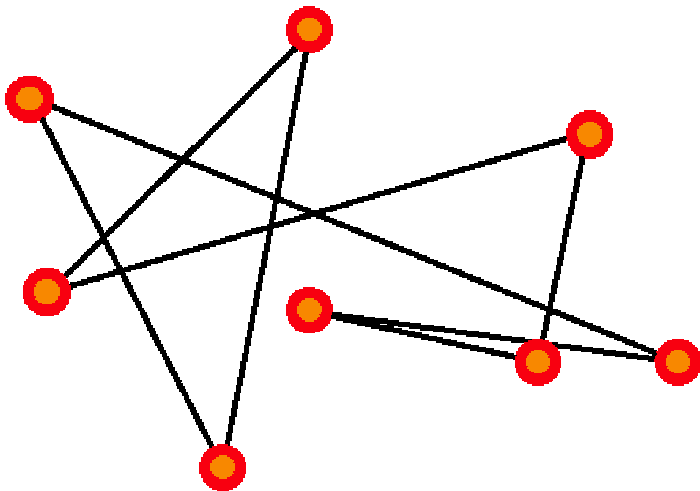

Complexity example: Traveling Salesman Problem

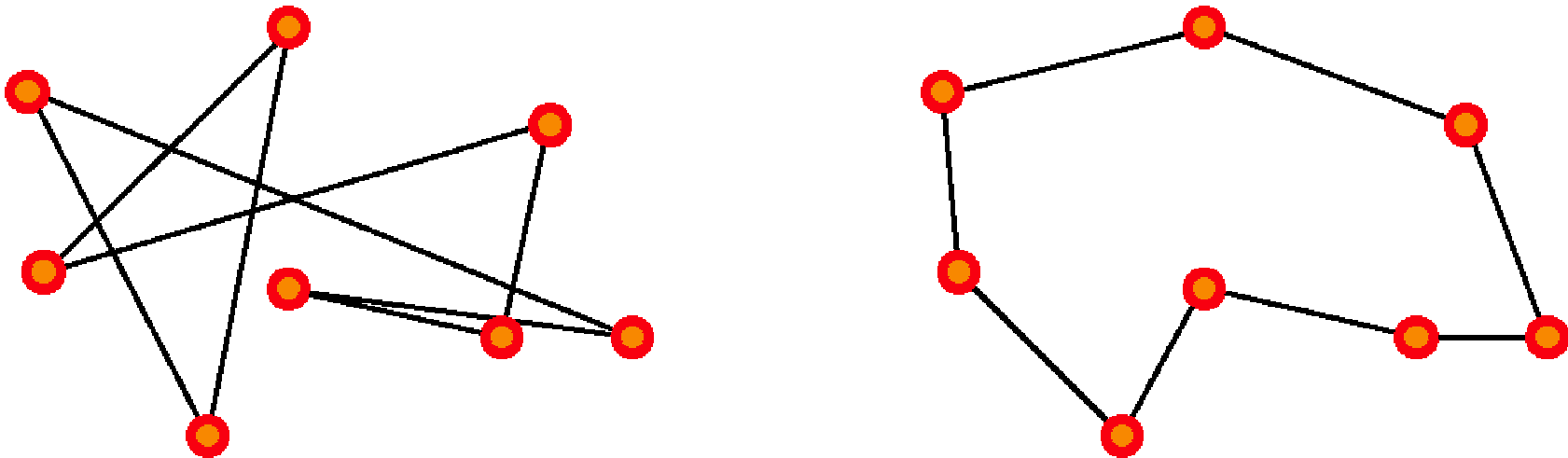

This is a *hard* problem: the only known algorithms (so far) to solve it have exponential complexity, that is, the number of operations required to solve it grows as $exp(n)$ for n cities.

Why is exponential complexity “hard”?

It means that the number of operations necessary to compute the exact solution of the problem grows exponentially with the size of the problem (here, the number of cities).

- $\exp(1) = 2.72$
- $\exp(10) = 2.20 \cdot 10^4$ (daily salesman trip)
- $\exp(100) = 2.69 \cdot 10^{43}$ (monthly salesman planning)
- $\exp(500) = 1.40 \cdot 10^{217}$ (music band worldwide tour)
- $\exp(250,000) = 10^{108,573}$ (fedex, postal services)
- Fastest computer = 10^{12} operations/second

So...



In general, exponential-complexity problems *cannot be solved for any but the smallest instances!*

Complexity



- **Polynomial-time (P) problems:** we can find algorithms that will solve them in a time (=number of operations) that grows polynomially with the size of the input.
- **for example:** sort n numbers into increasing order: poor algorithms have n^2 complexity, better ones have $n \log(n)$ complexity.

Complexity



- Since we did not state what the order of the polynomial is, it could be very large! Are there algorithms that require more than polynomial time?
- Yes (until proof of the contrary); for some algorithms, we do not know of any polynomial-time algorithm to solve them. These belong to the class of **nondeterministic-polynomial-time (NP)** algorithms (which includes P problems as well as harder ones).
- **for example:** traveling salesman problem.
- In particular, exponential-time algorithms are believed to be NP.

Note on NP-hard problems



- The formal definition of NP problems is:

A problem is **nondeterministic polynomial** if there exists some algorithm that can guess a solution and then verify whether or not the guess is correct in polynomial time.

(one can also state this as these problems being solvable in polynomial time on a nondeterministic Turing machine.)

In practice, until proof of the contrary, this means that known algorithms that run on known computer architectures will take more than polynomial time to solve the problem.

Complexity: $O()$ and $o()$ measures (Landau symbols)

- How can we represent the complexity of an algorithm?
- Given: Problem input (or instance) size: n
 Number of operations to solve problem: $f(n)$

- If, for a given function $g(n)$, we have:

$$\exists k \in \mathfrak{R}, \exists n_0 \in \mathbf{N}, \forall n \in \mathbf{N}, n \geq n_0, f(n) \leq kg(n)$$

then $f \in O(g)$ f is **dominated** by g

- If, for a given function $g(n)$, we have:

$$\forall k \in \mathfrak{R}, \exists n_0 \in \mathbf{N}, \forall n \in \mathbf{N}, n \geq n_0, f(n) \leq kg(n)$$

then $f \in o(g)$ f is **negligible** compared to g

Landau symbols

$$f \in O(g) \Leftrightarrow \exists k, \underbrace{f(n)}_{n \rightarrow \infty} \leq kg(n) \Leftrightarrow \frac{f}{g} \text{ is bounded}$$

$$f \in o(g) \Leftrightarrow \forall k, \underbrace{f(n)}_{n \rightarrow \infty} \leq kg(n) \Leftrightarrow \frac{f(n)}{g(n)} \xrightarrow{n \rightarrow \infty} 0$$

Examples, properties

- $f(n)=n, g(n)=n^2$:
 n is $o(n^2)$, because $n/n^2 = 1/n \rightarrow 0$ as $n \rightarrow \infty$
 similarly, $\log(n)$ is $o(n)$
 n^C is $o(\exp(n))$ for any C
- if f is $O(g)$, then for any K , $K.f$ is also $O(g)$; idem for $o()$
- if f is $O(h)$ and g is $O(h)$, then for any K, L : $K.f + L.g$ is $O(h)$
 idem for $o()$
- if f is $O(g)$ and g is $O(h)$, then f is $O(h)$
- if f is $O(g)$ and g is $o(h)$, then f is $o(h)$
- if f is $o(g)$ and g is $O(h)$, then f is $o(h)$

Polynomial-time hierarchy

- From Handbook of Brain Theory & Neural Networks (Arbib, ed.; MIT Press 1995).

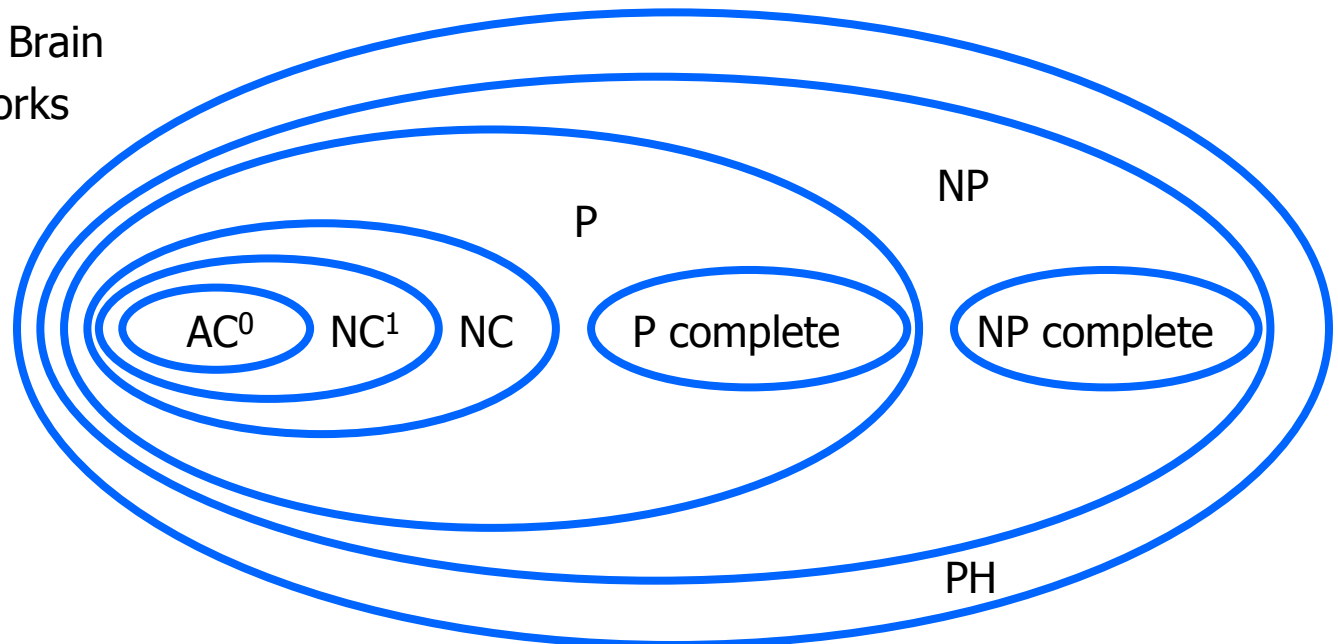

AC^0 : can be solved using gates of constant depth

NC^1 : can be solved in logarithmic depth using 2-input gates

NC : can be solved by small, fast parallel computer

P : can be solved in polynomial time

P -complete: hardest problems in P ; if one of them can be proven to be NC , then $P = NC$

NP : nondeterministic-polynomial algorithms

NP -complete: hardest NP problems; if one of them can be proven to be P , then $NP = P$

PH : polynomial-time hierarchy

Complexity and the human brain

- Are computers close to human brain power?
- Current computer chip (CPU):
 - 10^3 inputs (pins)
 - 10^7 processing elements (gates)
 - 2 inputs per processing element (fan-in = 2)
 - processing elements compute boolean logic (OR, AND, NOT, etc)
- Typical human brain:
 - 10^7 inputs (sensors)
 - 10^{10} processing elements (neurons)
 - fan-in = 10^3
 - processing elements compute complicated functions

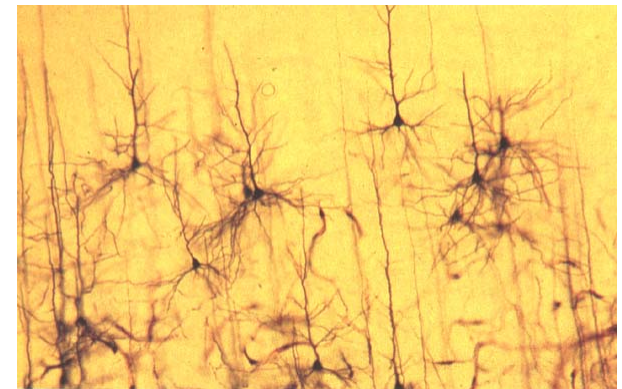

Still a lot of improvement needed for computers; but computer clusters come close!

Remember: Implementation of search algorithms

```
Function General-Search(problem, Queuing-Fn) returns a solution, or failure
nodes ← make-queue(make-node(initial-state[problem]))
loop do
  if nodes is empty then return failure
  node ← Remove-Front(nodes)
  if Goal-Test[problem] applied to State(node) succeeds then return node
  nodes ← Queuing-Fn(nodes, Expand(node, Operators[problem]))
end
```

Queuing-Fn(*queue*, *elements*) is a queuing function that inserts a set of elements into the queue and determines the order of node expansion. Varieties of the queuing function produce varieties of the search algorithm.

Encapsulating *state* information in *nodes*

A *state* is a (representation of) a physical configuration

A *node* is a data structure constituting part of a search tree

includes *parent*, *children*, *depth*, *path cost* $g(x)$

States do not have parents, children, depth, or path cost!

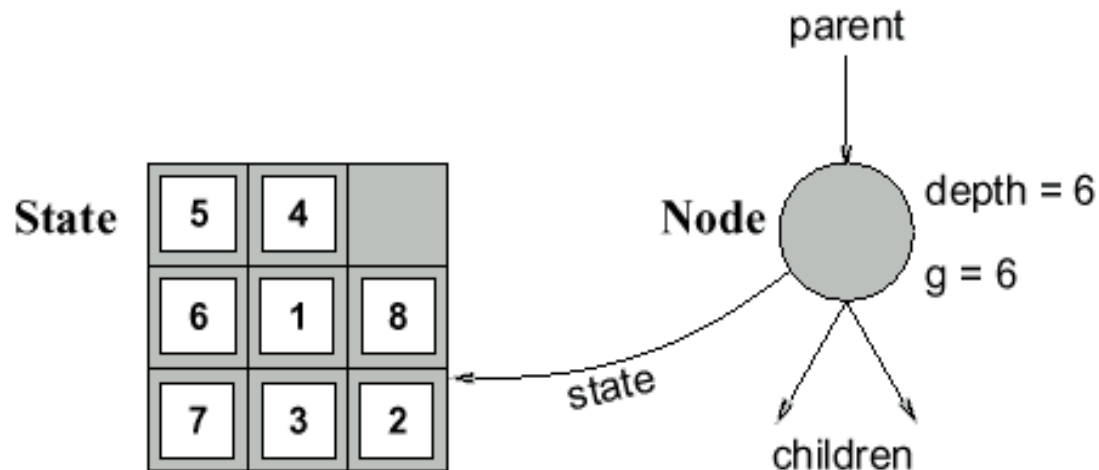

The EXPAND function creates new nodes, filling in the various fields and using the OPERATORS (or SUCCESSORFN) of the problem to create the corresponding states.

Evaluation of search strategies

- A search strategy is defined by **picking the order of node expansion**.
- Search algorithms are commonly evaluated according to the following four criteria:
 - **Completeness:** does it always find a solution if one exists?
 - **Time complexity:** how long does it take as function of num. of nodes?
 - **Space complexity:** how much memory does it require?
 - **Optimality:** does it guarantee the least-cost solution?
- Time and space complexity are measured in terms of:
 - b – max branching factor of the search tree
 - d – depth of the least-cost solution
 - m – max depth of the search tree (may be infinity)

Note: Approximations



- In our complexity analysis, we do not take the built-in loop-detection into account.
- The results only 'formally' apply to the variants of our algorithms **WITHOUT** loop-checks.
- Studying the effect of the loop-checking on the complexity is hard:
 - overhead of the checking MAY or MAY NOT be compensated by the reduction of the size of the tree.
- Also: our analysis **DOES NOT** take the length (space) of representing paths into account !!

<http://www.cs.kuleuven.ac.be/~dannyd/FAI/>

Uninformed search strategies



Use only information available in the problem formulation

- Breadth-first
- Uniform-cost
- Depth-first
- Depth-limited
- Iterative deepening

Breadth-first search

Expand shallowest unexpanded node

Implementation:

QUEUEINGFN = put successors at end of queue



Breadth-first search

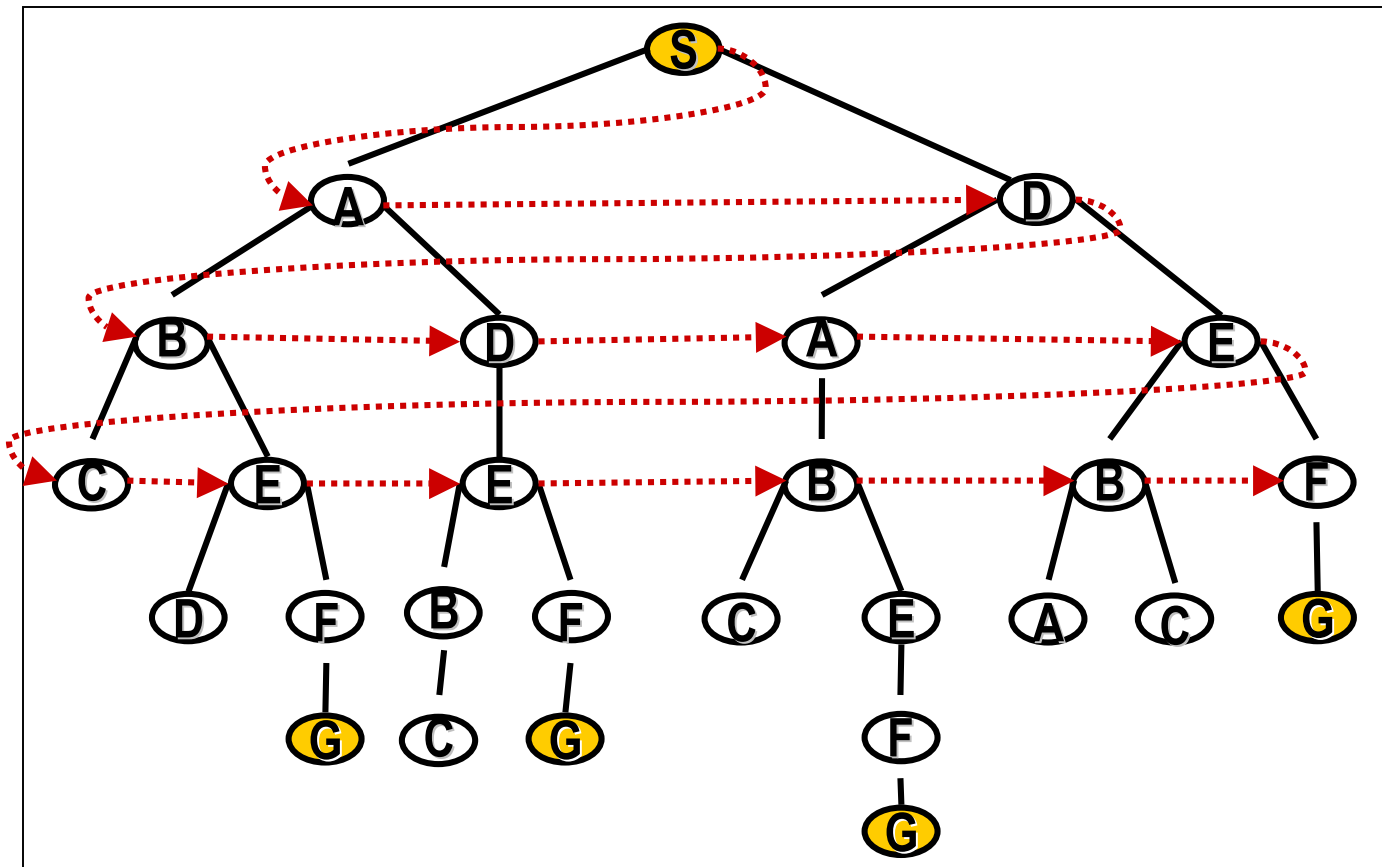

Move downwards,
level by level,
until goal is
reached.

Example: Traveling from Arad To Bucharest

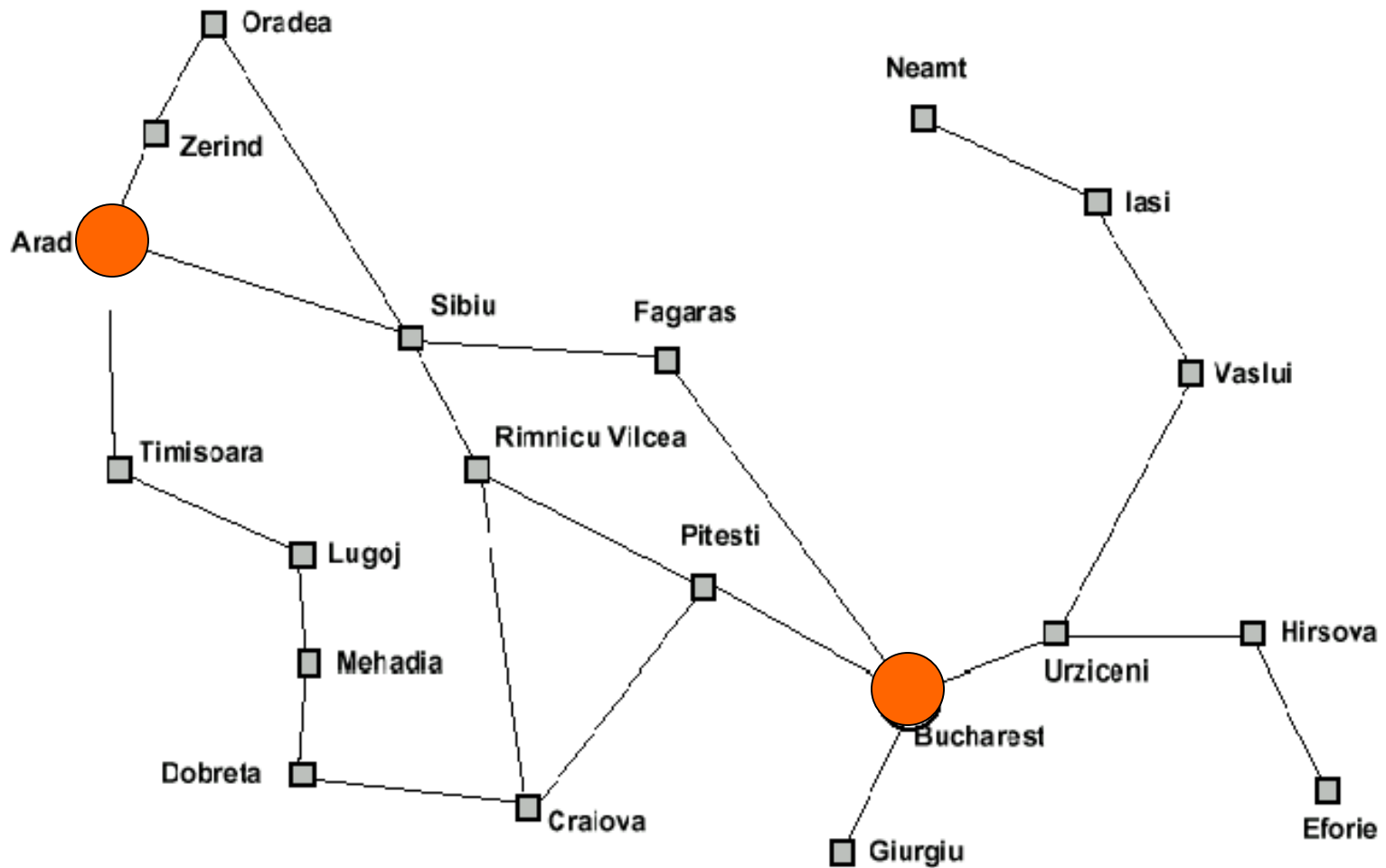

Breadth-first search

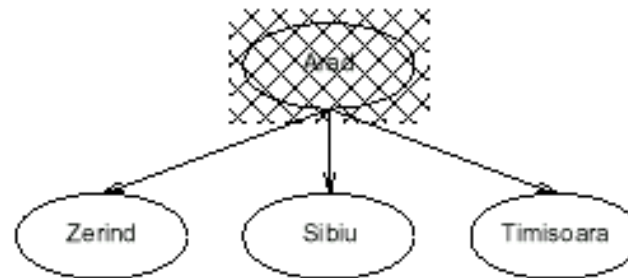

Breadth-first search

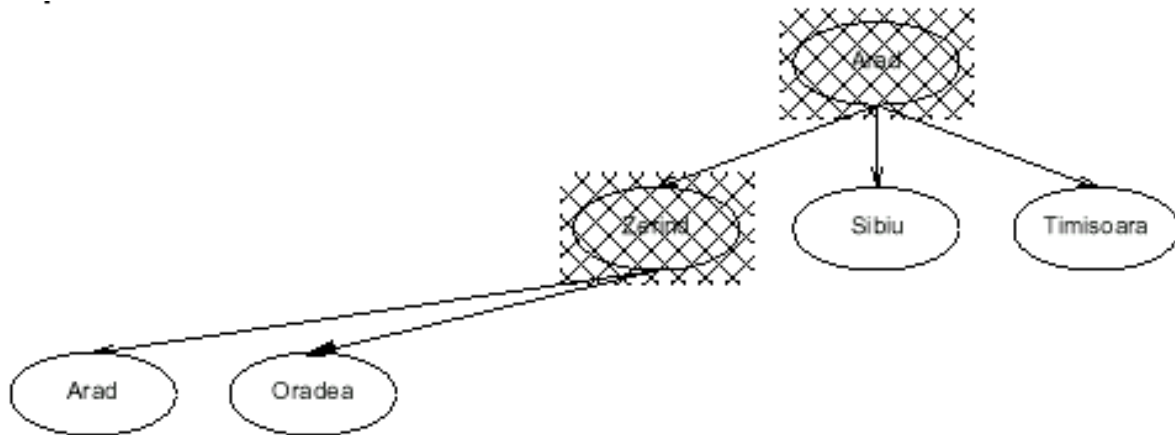

Breadth-first search

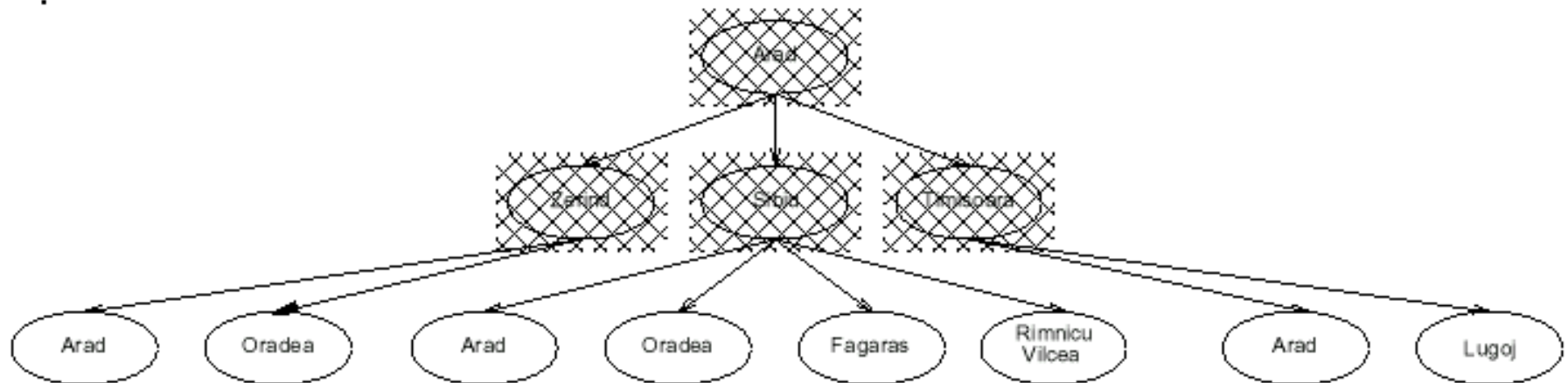

Properties of breadth-first search

- Completeness:
- Time complexity:
- Space complexity:
- Optimality:

- Search algorithms are commonly evaluated according to the following four criteria:
 - **Completeness:** does it always find a solution if one exists?
 - **Time complexity:** how long does it take as function of num. of nodes?
 - **Space complexity:** how much memory does it require?
 - **Optimality:** does it guarantee the least-cost solution?
- Time and space complexity are measured in terms of:
 - b – max branching factor of the search tree
 - d – depth of the least-cost solution
 - m – max depth of the search tree (may be infinity)

Properties of breadth-first search



- Completeness: Yes, if b is finite
- Time complexity: $1+b+b^2+\dots+b^d = O(b^d)$, i.e., exponential in d
- Space complexity: $O(b^d)$ (see following slides)
- Optimality: Yes (assuming cost = 1 per step)

Time complexity of breadth-first search

- If a goal node is found on depth d of the tree, all nodes up till that depth are created.

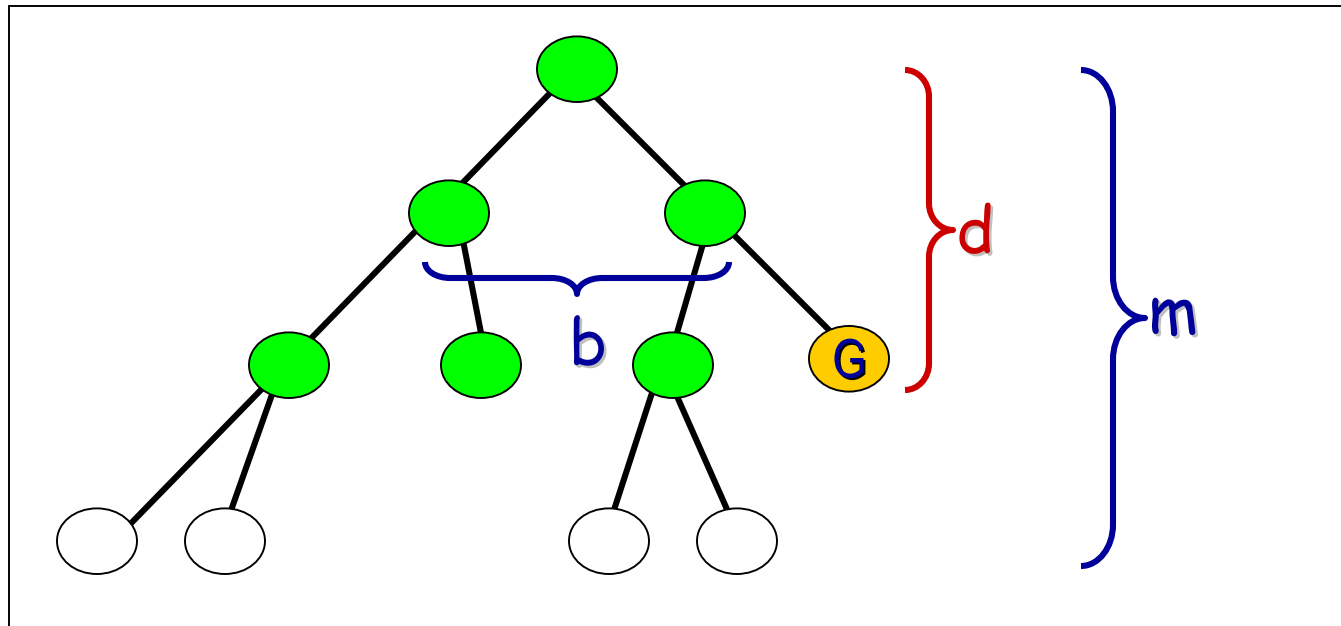

- Thus: $O(b^d)$

Space complexity of breadth-first

- Largest number of nodes in QUEUE is reached on the level d of the goal node.

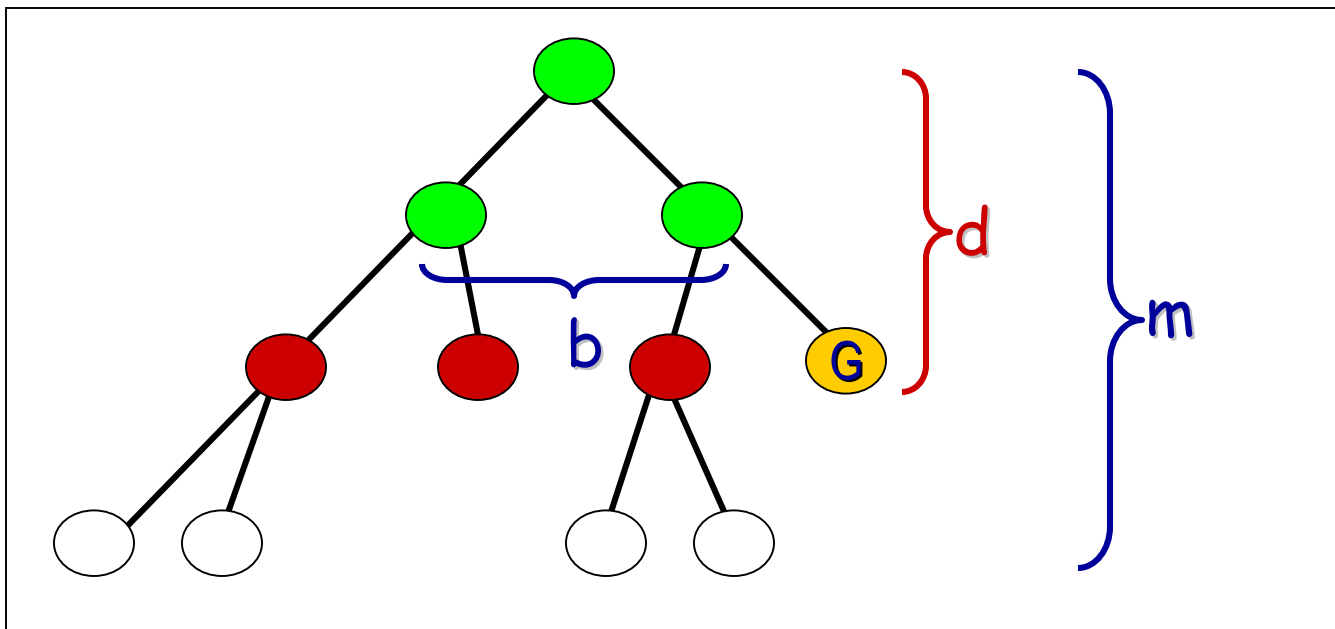

- QUEUE contains all ● and G nodes. (Thus: 4) .
- In General: b^d

Uniform-cost search

Expand least-cost unexpanded node

Implementation:

QUEUEINGFN = insert in order of increasing path cost



So, the queueing function keeps the node list sorted by increasing path cost, and we expand the first unexpanded node (hence with smallest path cost)

A refinement of the breadth-first strategy:

Breadth-first = uniform-cost with path cost = node depth

Romania with step costs in km

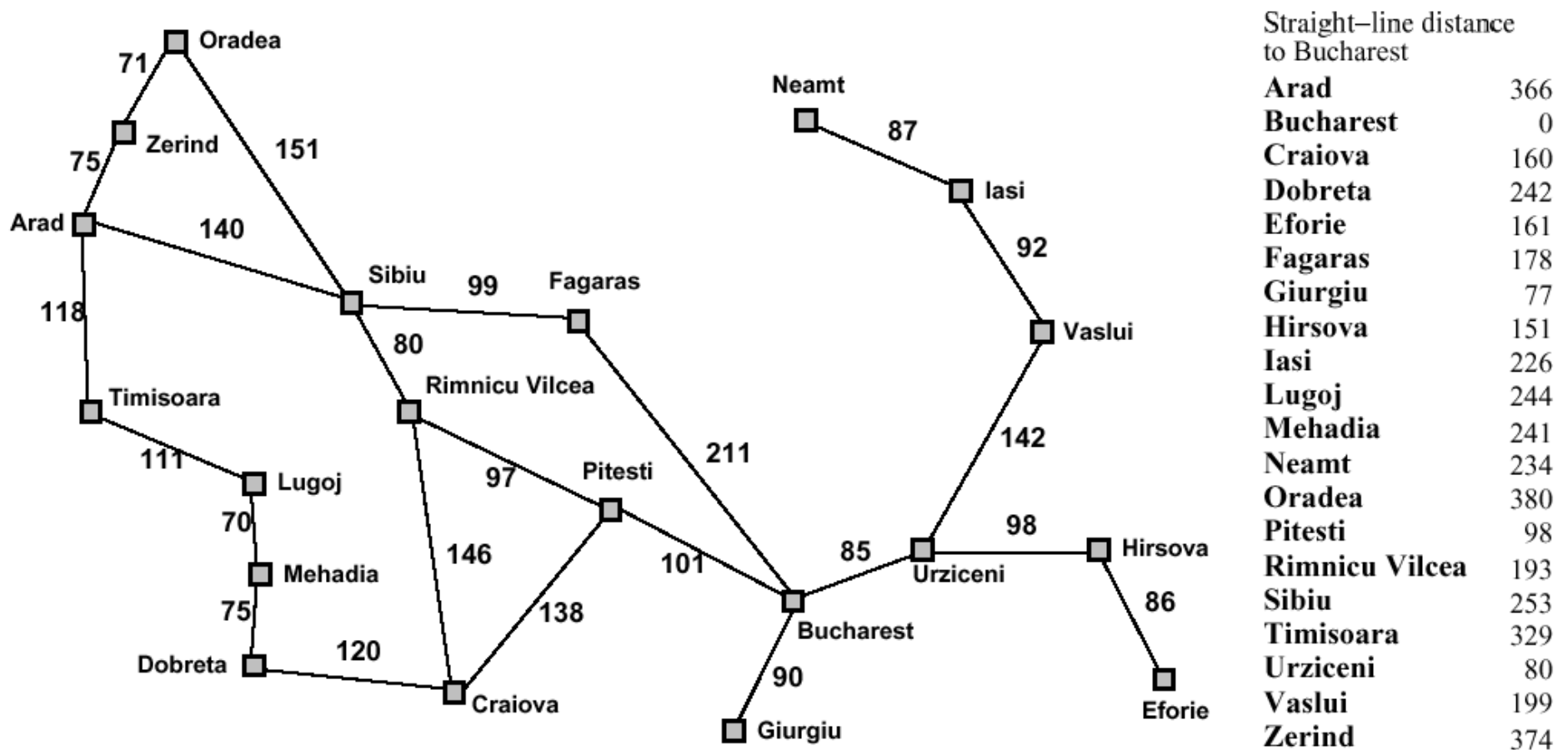

Uniform-cost search

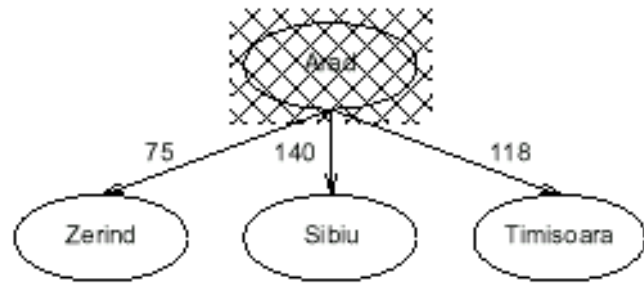

Uniform-cost search

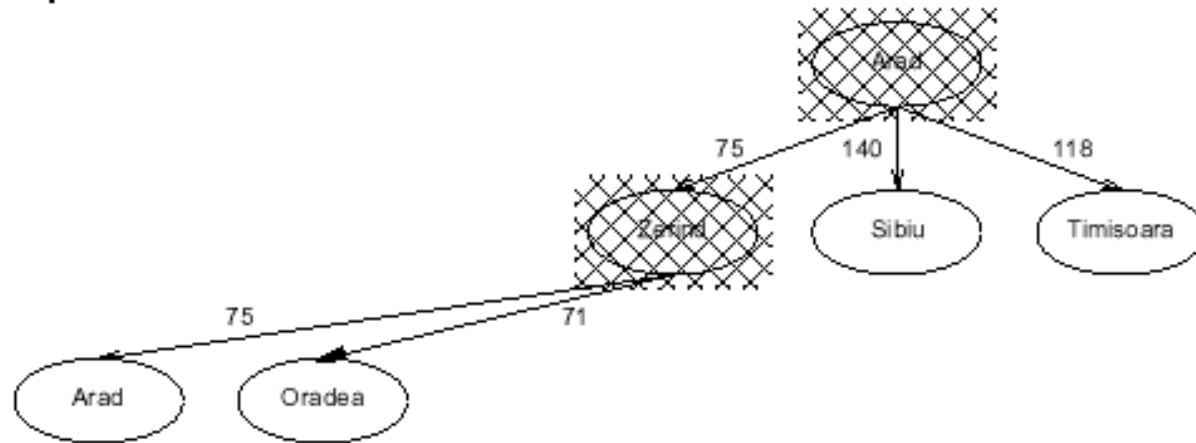

Uniform-cost search

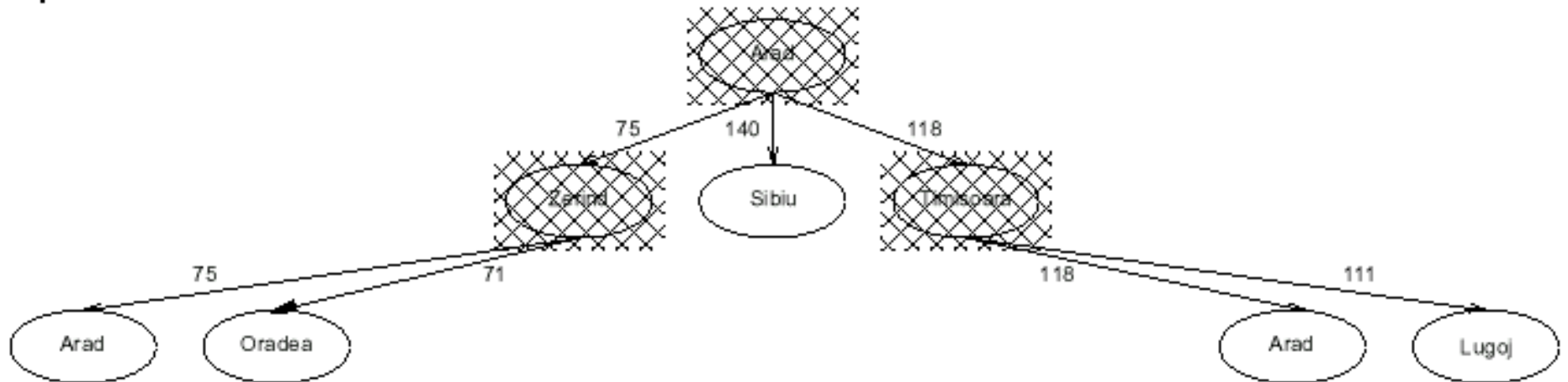

Properties of uniform-cost search

- Completeness: Yes, if step cost $\geq \epsilon > 0$
- Time complexity: # nodes with $g \leq$ cost of optimal solution, $\leq O(b^d)$
- Space complexity: # nodes with $g \leq$ cost of optimal solution, $\leq O(b^d)$
- Optimality: Yes, as long as path cost never decreases

$g(n)$ is the path cost to node n

Remember:

b = branching factor

d = depth of least-cost solution

Implementation of uniform-cost search

- Initialize **Queue** with root node (built from start state)
- Repeat until (**Queue** empty) or (first node has **Goal state**):
 - Remove first node from front of Queue
 - Expand node (find its children)
 - Reject those children that have already been considered, to avoid loops
 - Add remaining children to Queue, *in a way that keeps entire queue sorted by increasing path cost*
- If Goal was reached, return success, otherwise failure

Caution!

- Uniform-cost search not optimal if it is terminated when **any** node in the queue has goal state.

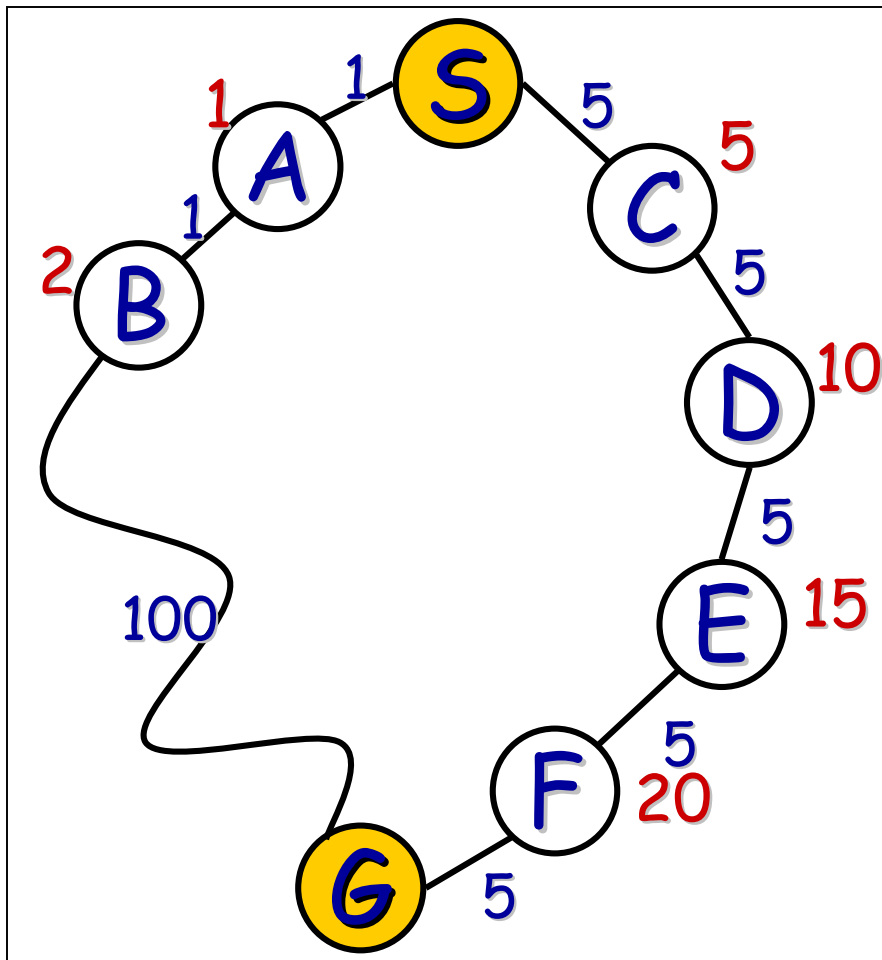

- Uniform cost returns the path with cost 102 (if any goal node is considered a solution), while there is a path with cost 25.

Note: Loop Detection

- In class, we saw that the search may fail or be sub-optimal if:
 - no loop detection: then algorithm runs into infinite cycles
(A -> B -> A -> B -> ...)
 - not queuing-up a node that has a state which we have already visited: may yield suboptimal solution
 - simply avoiding to go back to our parent: looks promising, but we have not proven that it works

Solution? do not enqueue a node if its state matches the state of any of its parents (assuming path costs > 0).

Indeed, if path costs > 0, it will always cost us more to consider a node with that state again than it had already cost us the first time.

Is that enough??

Example

From: <http://www.csee.umbc.edu/471/current/notes/uninformed-search/>

Example Illustrating Uninformed Search Strategies

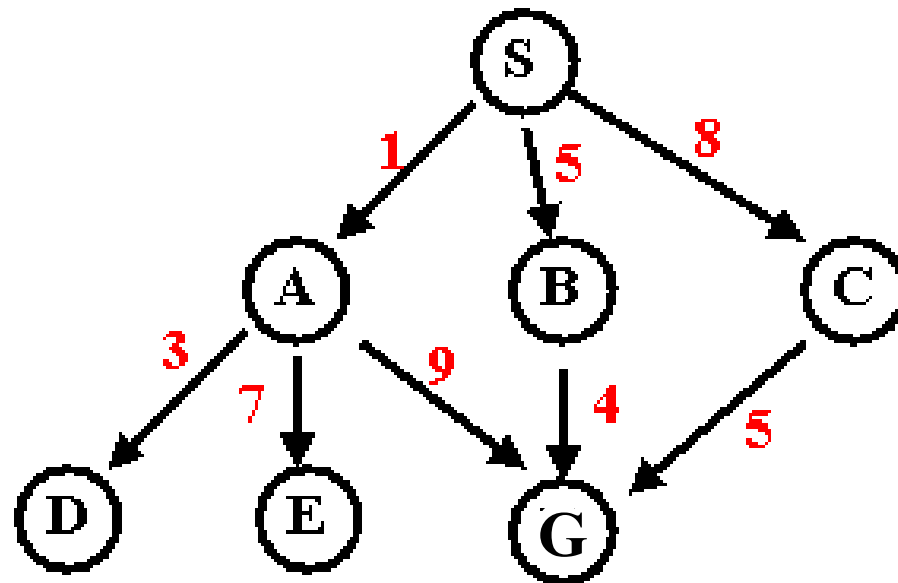

Breadth-First Search Solution

From: <http://www.csee.umbc.edu/471/current/notes/uninformed-search/>

Breadth-First Search

```
return GENERAL-SEARCH(problem, ENQUEUE-AT-END)
```

exp. node nodes list

```
      { S }
S     { A B C }
A     { B C D E G }
B     { C D E G G' }
C     { D E G G' G'' }
D     { E G G' G'' }
E     { G G' G'' }
G     { G' G'' }
```

Solution path found is S A G <-- this G also has cost 10

Number of nodes expanded (including goal node) = 7

Uniform-Cost Search Solution

From: <http://www.csee.umbc.edu/471/current/notes/uninformed-search/>

Uniform-Cost Search

GENERAL-SEARCH(problem, ENQUEUE-BY-PATH-COST)

exp. node nodes list

	{ S }
S	{ A(1) B(5) C(8) }
A	{ D(4) B(5) C(8) E(8) G(10) } (NB, we don't return G)
D	{ B(5) C(8) E(8) G(10) }
B	{ C(8) E(8) G(9) G(10) }
C	{ E(8) G(9) G(10) G(13) }
E	{ G(9) G(10) G(13) }
G	{ }

Solution path found is S B G <-- this G has cost 9, not 10

Number of nodes expanded (including goal node) = 7

Note: Queueing in Uniform-Cost Search

In the previous example, it is wasteful (but not incorrect) to queue-up three nodes with G state, if our goal is to find the least-cost solution:

Although they represent different paths, we know for sure that the one with smallest path cost (9 in the example) will yield a solution with smaller total path cost than the others.

So we can refine the queueing function by:

- queue-up node if

- 1) its state does not match the state of any parent

and

- 2) path cost smaller than path cost of any

unexpanded node with same state in the queue
(and in this case, replace old node with same state by our new node)

Is that it??

A Clean Robust Algorithm

```
Function UniformCost-Search(problem, Queuing-Fn) returns a solution, or failure
  open ← make-queue(make-node(initial-state[problem]))
  closed ← [empty]
  loop do
    if open is empty then return failure
    currnode ← Remove-Front(open)
    if Goal-Test[problem] applied to State(currnode) then return currnode
    children ← Expand(currnode, Operators[problem])
    while children not empty
      [... see next slide ...]
    end
    closed ← Insert(closed, currnode)
    open ← Sort-By-PathCost(open)
  end
```

A Clean Robust Algorithm

[... see previous slide ...]

```
children ← Expand(currnode, Operators[problem])
while children not empty
  child ← Remove-Front(children)
  if no node in open or closed has child's state
    open ← Queuing-Fn(open, child)
  else if there exists node in open that has child's state
    if PathCost(child) < PathCost(node)
      open ← Delete-Node(open, node)
      open ← Queuing-Fn(open, child)
  else if there exists node in closed that has child's state
    if PathCost(child) < PathCost(node)
      closed ← Delete-Node(closed, node)
      open ← Queuing-Fn(open, child)
end
```

[... see previous slide ...]

Example

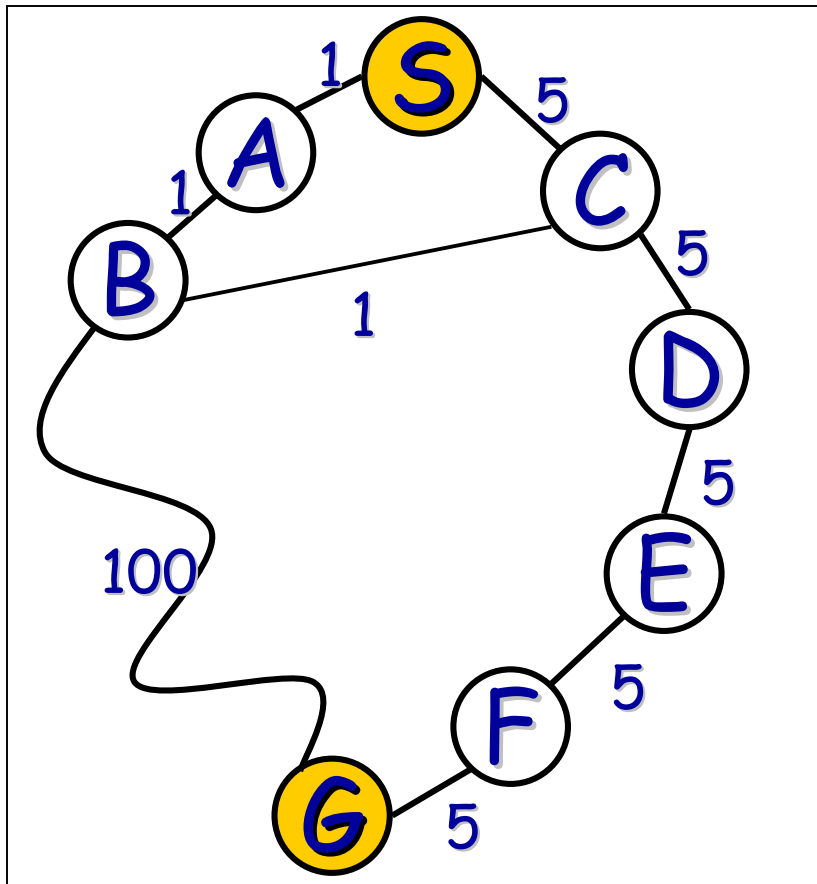

#	State	Depth	Cost	Parent
1	S	0	0	-

Example

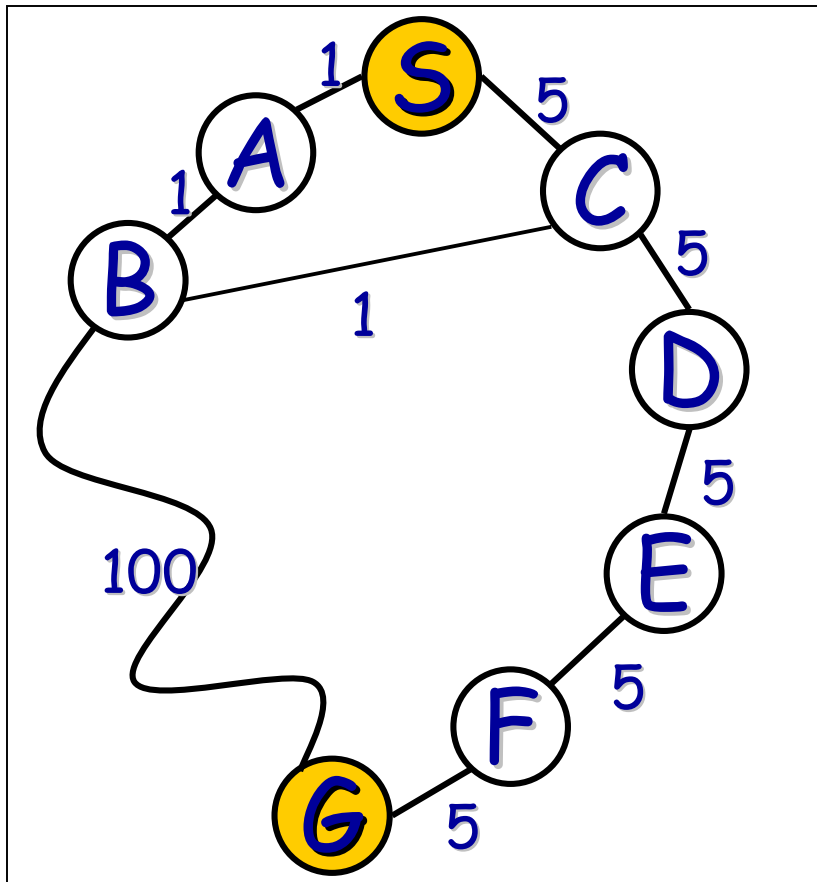

#	State	Depth	Cost	Parent
1	S	0	0	-
2	A	1	1	1
3	C	1	5	1

Black = open queue
 Grey = closed queue

Insert expanded nodes
 Such as to keep *open* queue
 sorted

Example

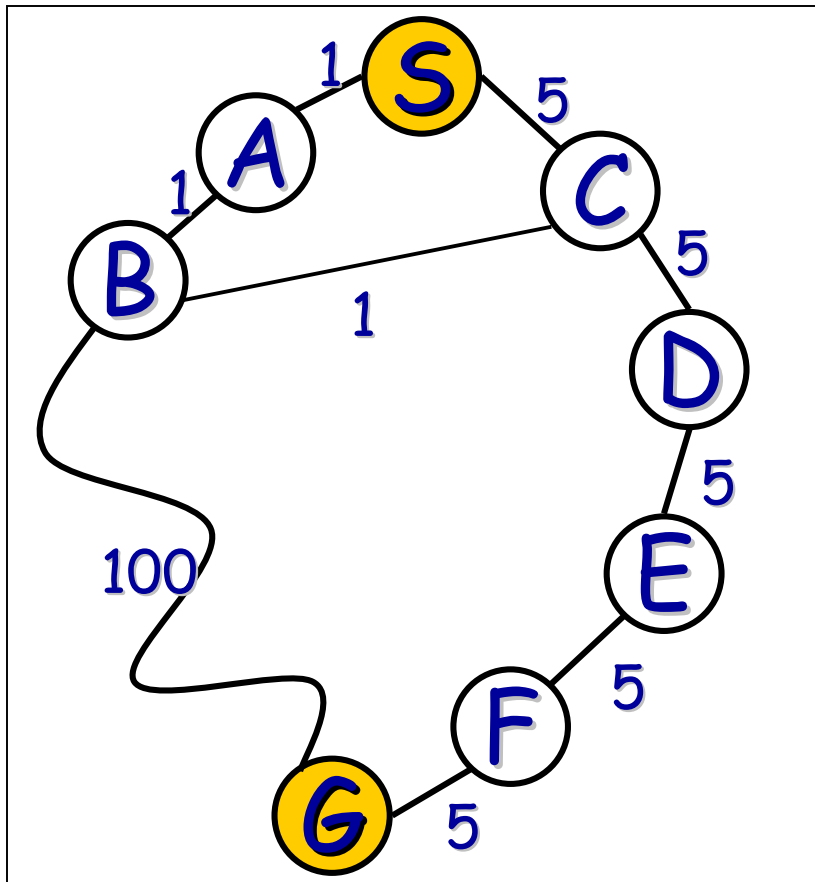

#	State	Depth	Cost	Parent
1	S	0	0	-
2	A	1	1	1
4	B	2	2	2
3	C	1	5	1

Node 2 has 2 successors: one with state B and one with state S.

We have node #1 in *closed* with state S; but its path cost 0 is smaller than the path cost obtained by expanding from A to S. So we do not queue-up the successor of node 2 that has state S.

Example

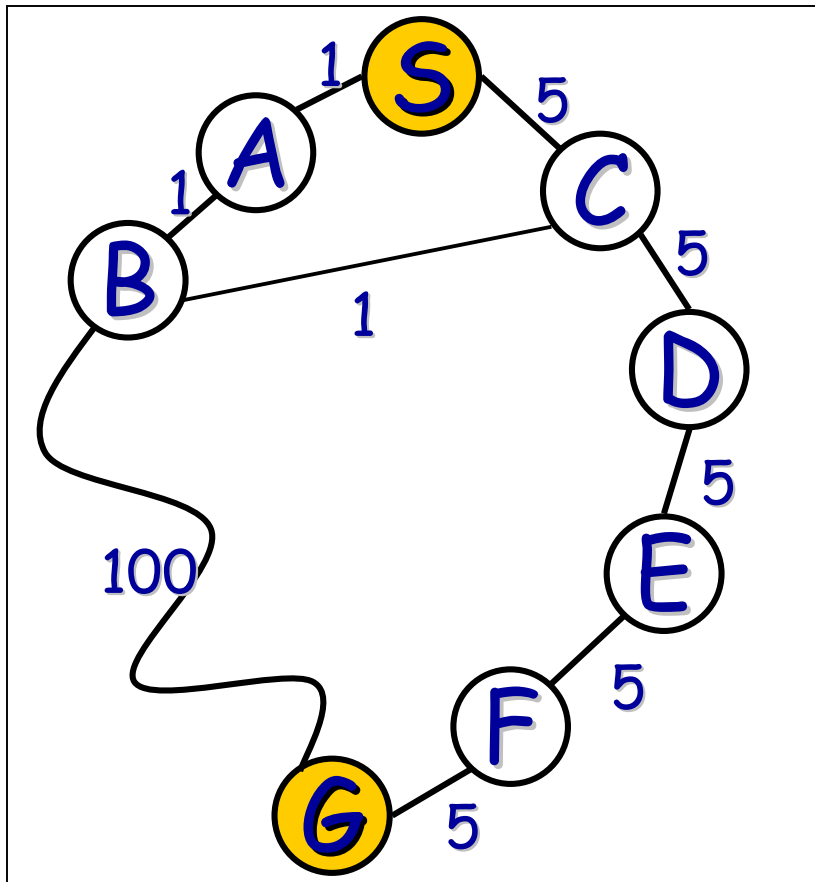

#	State	Depth	Cost	Parent
1	S	0	0	-
2	A	1	1	1
4	B	2	2	2
5	C	3	3	4
6	G	3	102	4

Node 4 has a successor with state C and Cost smaller than node #3 in *open* that Also had state C; so we update *open* To reflect the shortest path.

Example

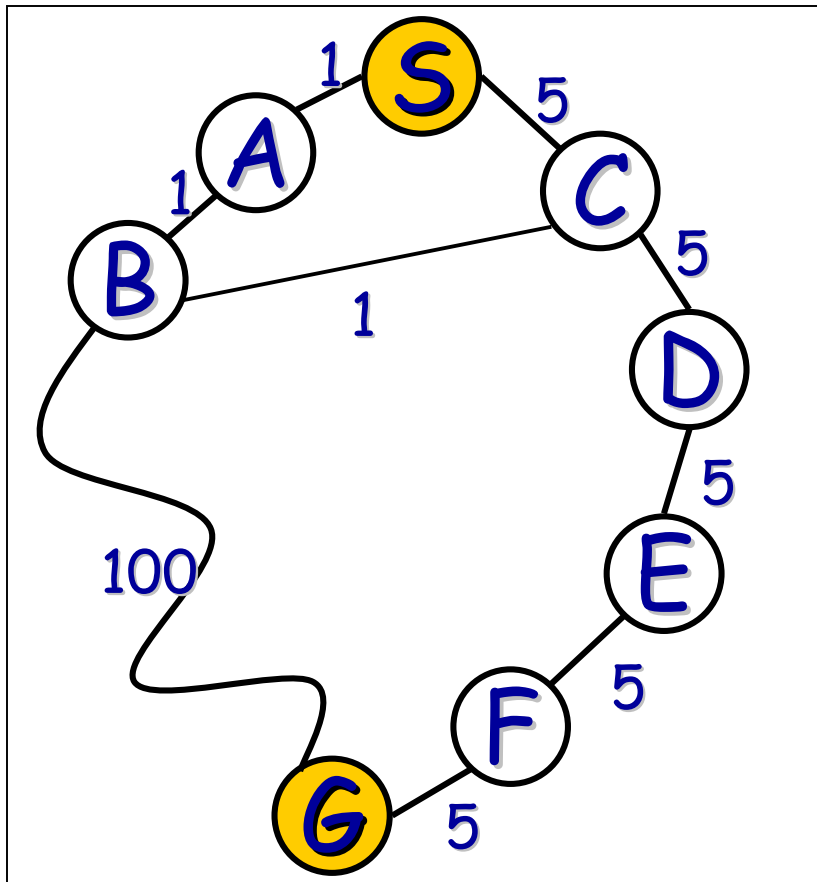

#	State	Depth	Cost	Parent
1	S	0	0	-
2	A	1	1	1
4	B	2	2	2
5	C	3	3	4
7	D	4	8	5
6	G	3	102	4

Example

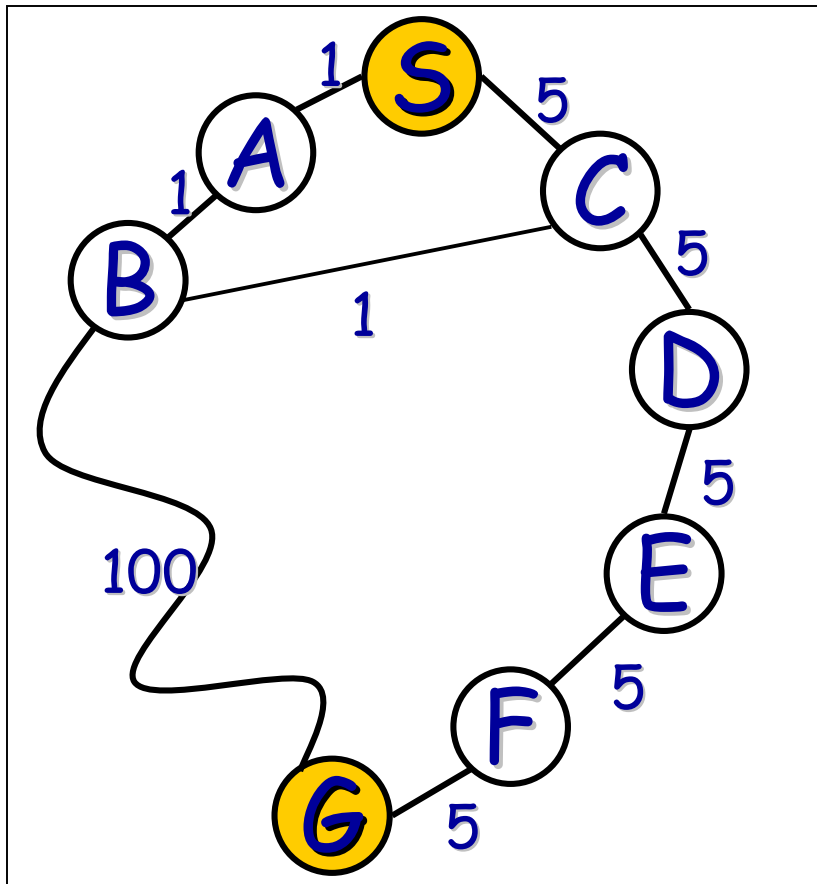

#	State	Depth	Cost	Parent
1	S	0	0	-
2	A	1	1	1
4	B	2	2	2
5	C	3	3	4
7	D	4	8	5
8	E	5	13	7
6	G	3	102	4

Example

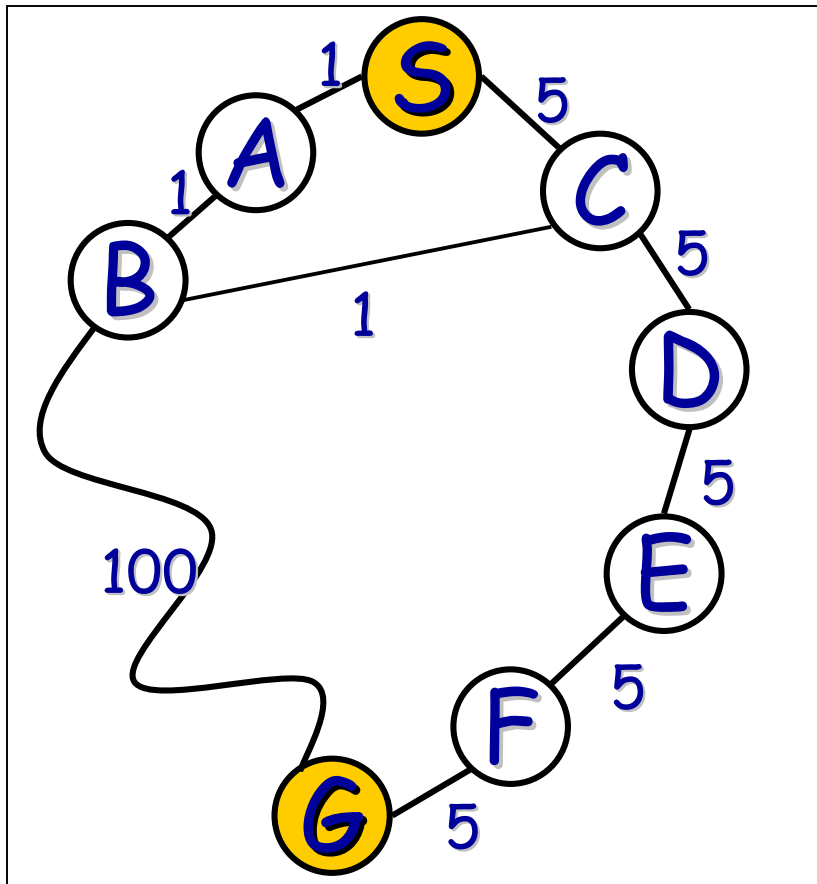

#	State	Depth	Cost	Parent
1	S	0	0	-
2	A	1	1	1
4	B	2	2	2
5	C	3	3	4
7	D	4	8	5
8	E	5	13	7
9	F	6	18	8
6	G	3	102	4

Example

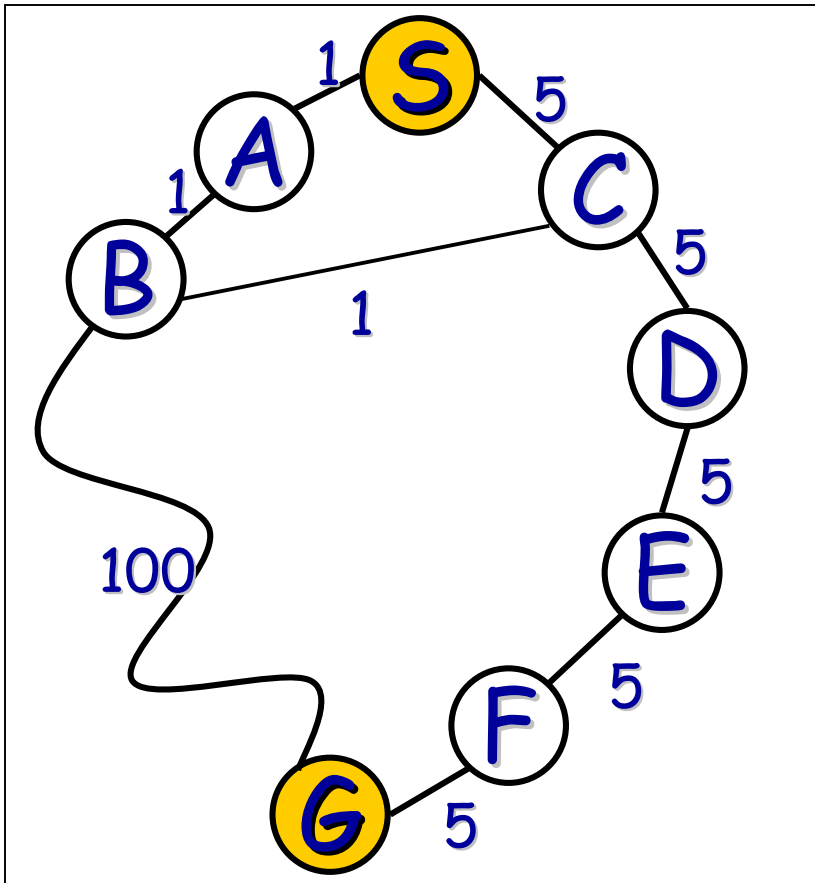

#	State	Depth	Cost	Parent
1	S	0	0	-
2	A	1	1	1
4	B	2	2	2
5	C	3	3	4
7	D	4	8	5
8	E	5	13	7
9	F	6	18	8
10	G	7	23	9
6	G	3	102	4

Example

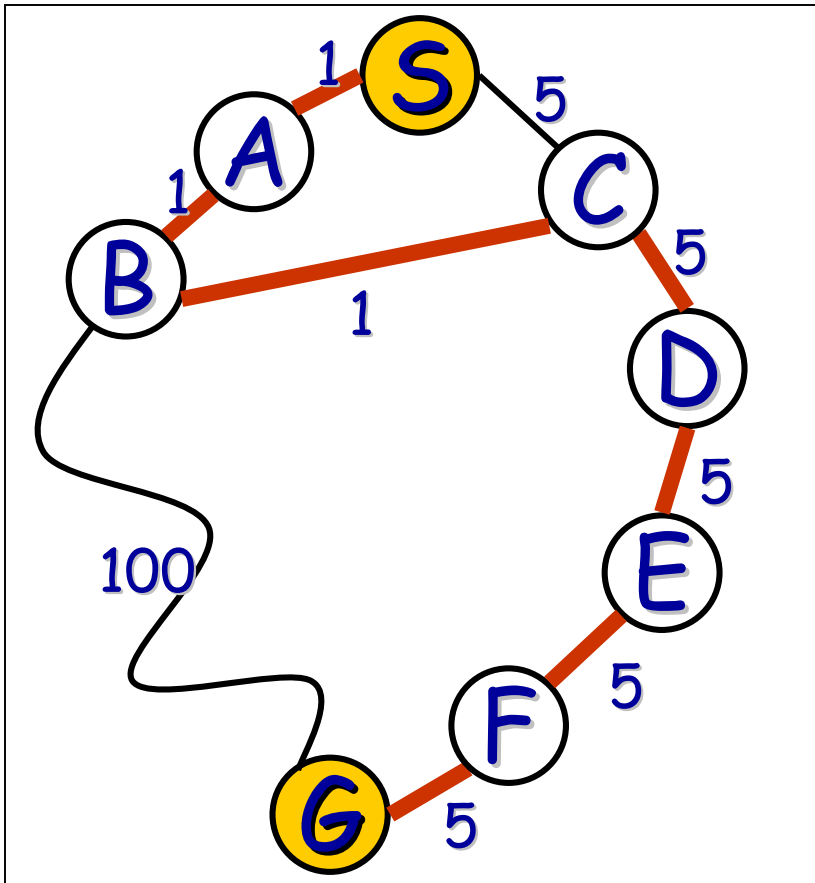

#	State	Depth	Cost	Parent
1	S	0	0	-
2	A	1	1	1
4	B	2	2	2
5	C	3	3	4
7	D	4	8	5
8	E	5	13	7
9	F	6	18	8
10	G	7	23	9
6	G	3	102	4

Goal reached

More examples...



- See the great demos at:

<http://pages.pomona.edu/~jbm04747/courses/spring2001/cs151/Search/Strategies.html>

Depth-first search

Expand deepest unexpanded node

Implementation:

QUEUEINGFN = insert successors at front of queue



Depth First Search

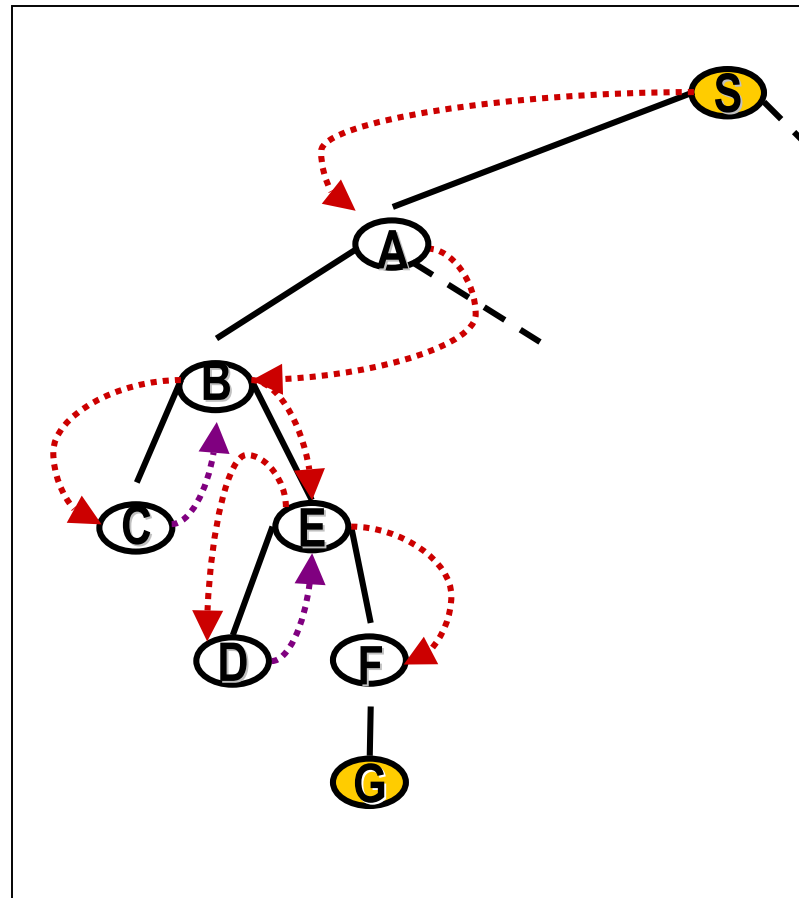

Romania with step costs in km

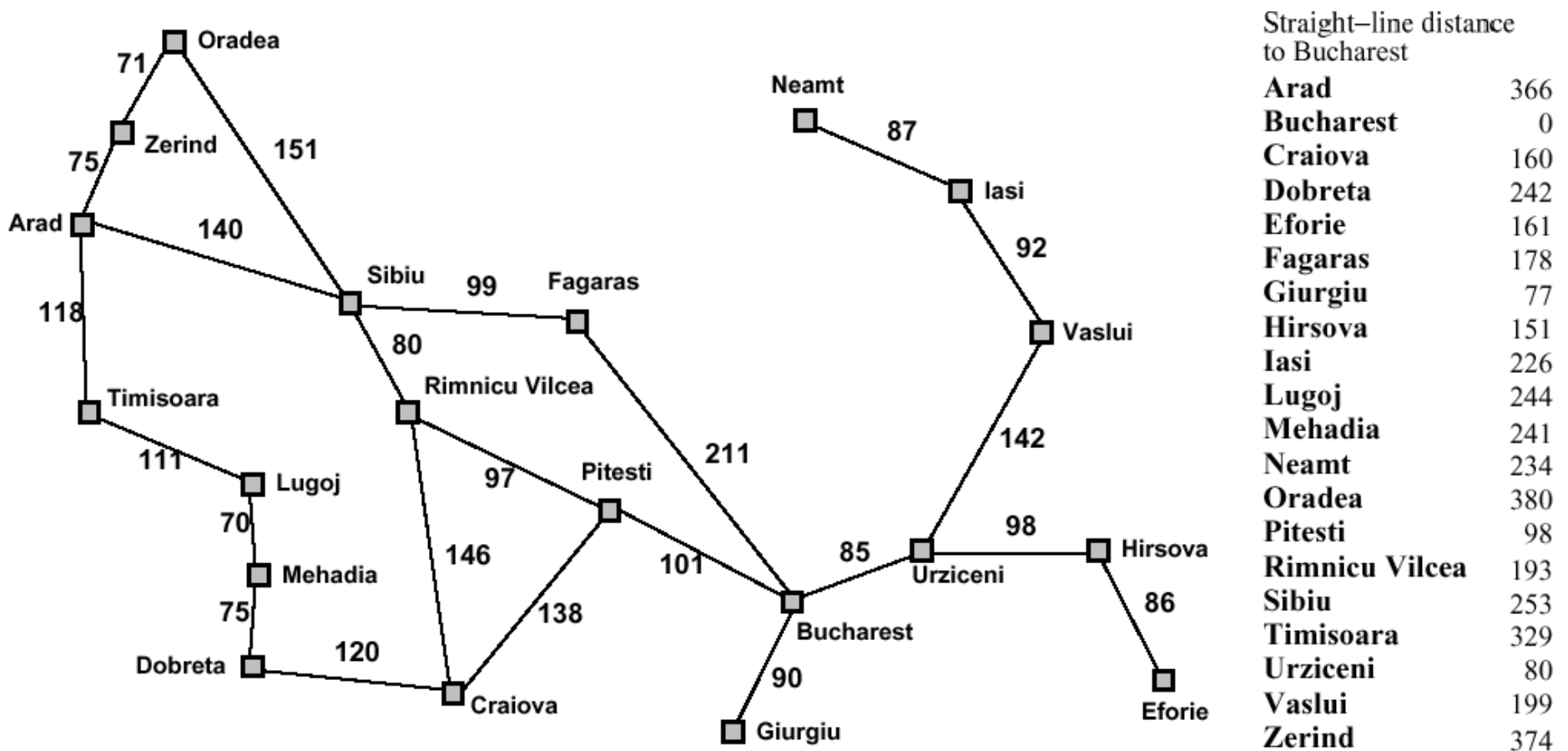

Depth-first search

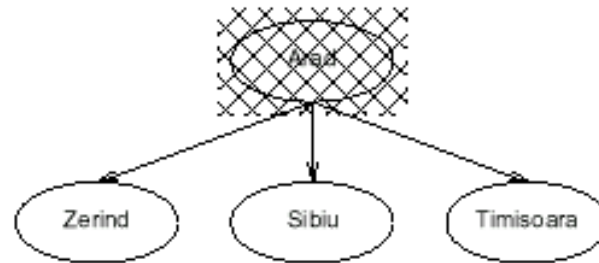

Depth-first search

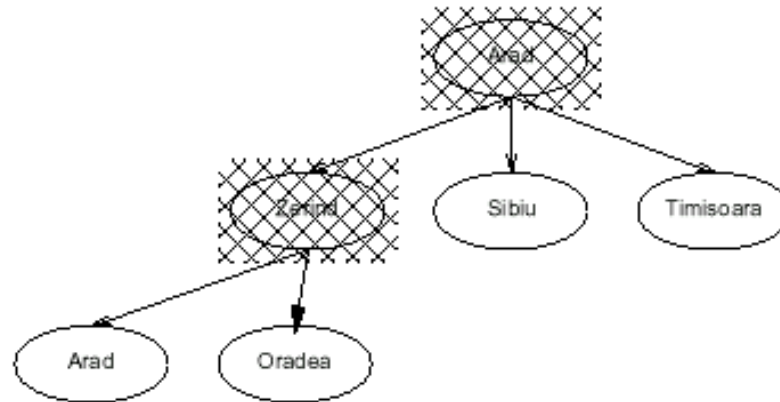

Depth-first search

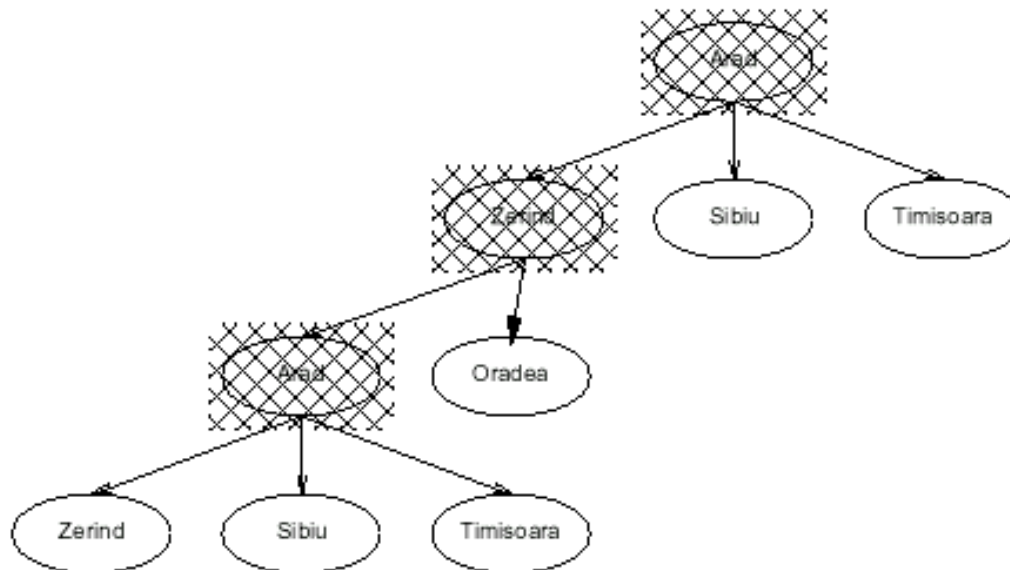

I.e., depth-first search can perform infinite cyclic excursions
Need a finite, non-cyclic search space (or repeated-state checking)

Properties of depth-first search

- Completeness: No, fails in infinite state-space (yes if finite state space)
- Time complexity: $O(b^m)$
- Space complexity: $O(bm)$
- Optimality: No

Remember:

b = branching factor

m = max depth of search tree

Time complexity of depth-first: details

- In the worst case:
 - the (only) goal node may be on the right-most branch,

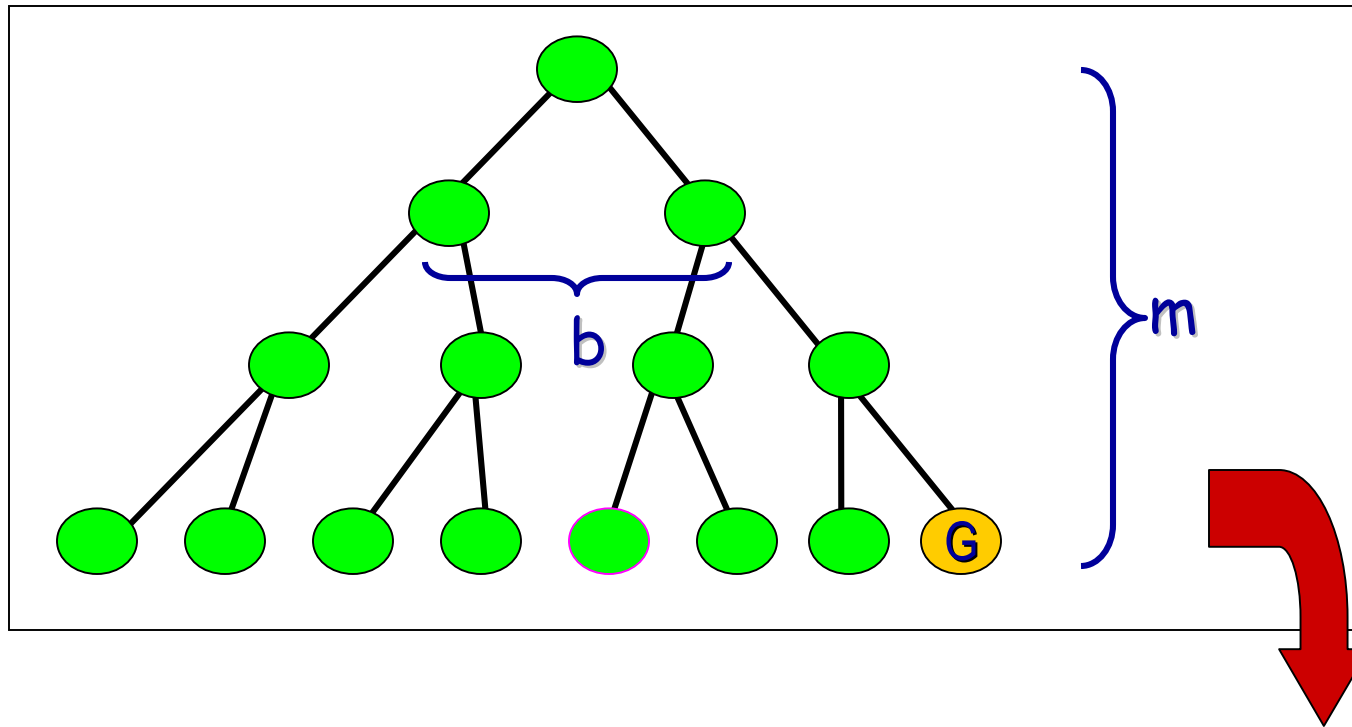

- Time complexity $= b^m + b^{m-1} + \dots + 1 = \frac{b^{m+1} - 1}{b - 1}$
- Thus: $O(b^m)$

Avoiding repeated states



In increasing order of effectiveness and computational overhead:

- **do not return to state we come from**, i.e., expand function will skip possible successors that are in same state as node's parent.
- **do not create paths with cycles**, i.e., expand function will skip possible successors that are in same state as any of node's ancestors.
- **do not generate any state that was ever generated before**, by keeping track (in memory) of every state generated, unless the cost of reaching that state is lower than last time we reached it.

Depth-limited search



Is a depth-first search with depth limit l

Implementation:

Nodes at depth l have no successors.

Complete: if cutoff chosen appropriately then it is guaranteed to find a solution.

Optimal: it does not guarantee to find the least-cost solution

Iterative deepening search

```
Function Iterative-deepening-Search(problem) returns a solution,  
or failure  
  
for depth = 0 to  $\infty$  do  
    result  $\leftarrow$  Depth-Limited-Search(problem, depth)  
    if result succeeds then return result  
end  
return failure
```

Combines the best of breadth-first and depth-first search strategies.

- Completeness: Yes,
- Time complexity: $O(b^d)$
- Space complexity: $O(bd)$
- Optimality: Yes, if step cost = 1

Romania with step costs in km

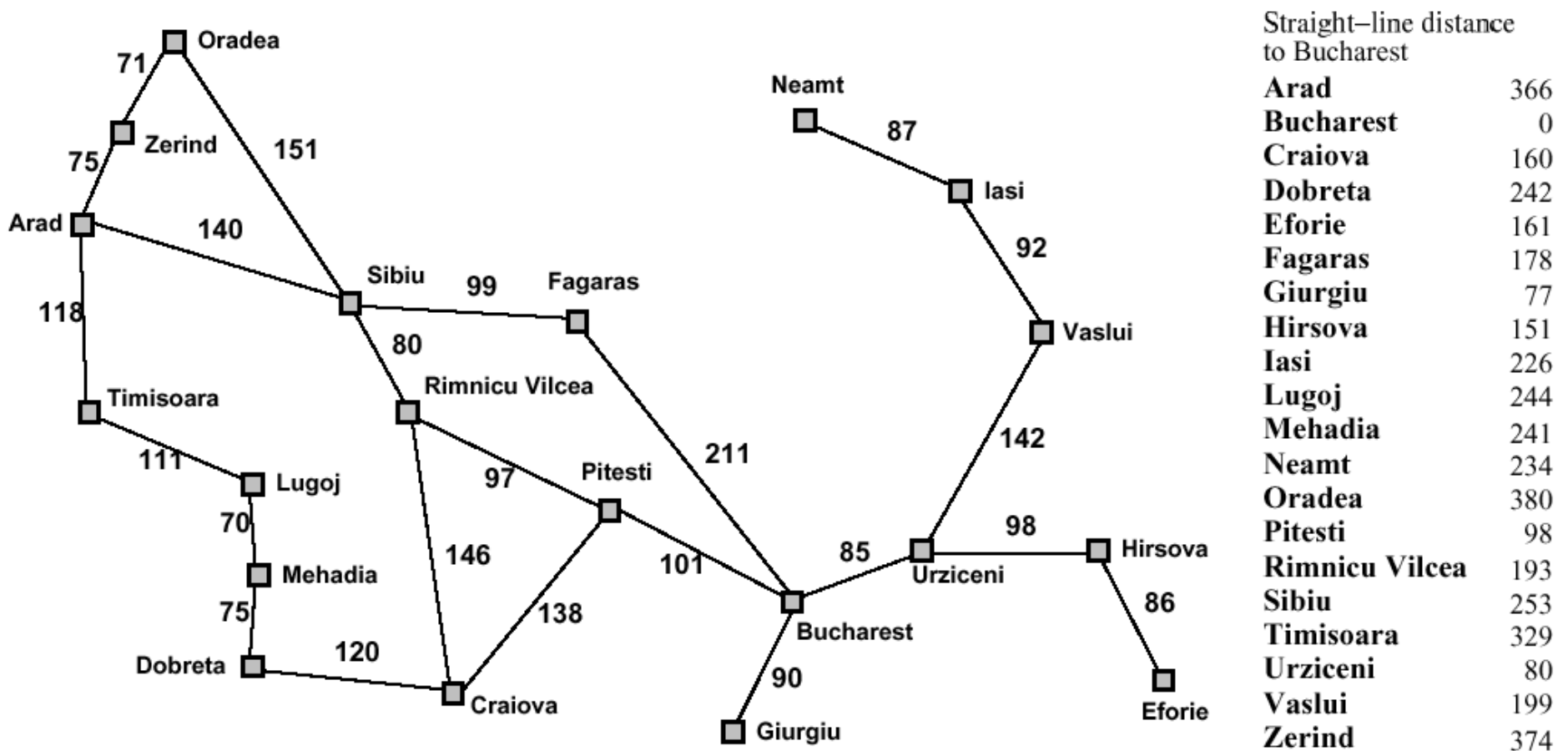

Adobe Acrobat - [chapter03.pdf]

File Edit Document Tools View Window Help

Iterative deepening search $l = 0$

Arad

AIMA Slides ©Stuart Russell and Peter Norvig, 1998

Chapter 3, Sections 1.5 53

153% 53 of 63 11 x 8.5 in

Start CS 564 laurent talks CS 561a Adobe Acr... Microsoft Pow... Telnet - pollux... books Adobe Photos... 8:22 PM

Adobe Acrobat - [chapter03.pdf]

File Edit Document Tools View Window Help

Iterative deepening search $l = 1$

Arad

AIMA Slides ©Stuart Russell and Peter Norvig, 1998

Chapter 3, Sections 1.5 54

153% 54 of 63 11 x 8.5 in

Start CS 564 laurent talks CS 561a Adobe Acr... Microsoft Pow... Telnet - pollux... books Adobe Photos... 8:24 PM

Adobe Acrobat - [chapter03.pdf]

File Edit Document Tools View Window Help

```
graph TD; Arad((Arad)) --> Zerind((Zerind)); Arad --> Sibiu((Sibiu)); Arad --> Timisoara((Timisoara));
```

AIMA Slides ©Stuart Russell and Peter Norvig, 1998

Chapter 3, Sections 1 5 55

153% 55 of 63 11 x 8.5 in

Start CS 564 laurent talks CS 561a Aima Adobe Acr... Microsoft Pow... Telnet - pollux... books Adobe Photos... 8:24 PM

Adobe Acrobat - [chapter03.pdf]

File Edit Document Tools View Window Help

Iterative deepening search $l = 2$

Arad

AIMA Slides ©Stuart Russell and Peter Norvig, 1998

Chapter 3, Sections 1.5 56

153% 56 of 63 11 x 8.5 in

Start CS 564 laurent talks CS 561a Adobe Acr... Microsoft Pow... Telnet - pollux... books Adobe Photos... 8:25 PM

Adobe Acrobat - [chapter03.pdf]

File Edit Document Tools View Window Help

```
graph TD; Arad((Arad)) --> Zerind((Zerind)); Arad --> Sibiu((Sibiu)); Arad --> Timisoara((Timisoara));
```

AIMA Slides ©Stuart Russell and Peter Norvig, 1998

Chapter 3, Sections 1 5 57

153% 57 of 63 11 x 8.5 in

Start CS 564 laurent talks CS 561a Aima Adobe Acr... Microsoft Pow... Telnet - pollux... books Adobe Photos... 8:25 PM

Adobe Acrobat - [chapter03.pdf]

File Edit Document Tools View Window Help

```
graph TD; Arad1((Arad)) --> Zerind((Zerind)); Arad1 --> Sibiu((Sibiu)); Arad1 --> Timisoara((Timisoara)); Zerind --> Arad2((Arad)); Zerind --> Oradea((Oradea));
```

Arad

Zerind

Sibiu

Timisoara

Arad

Oradea

AIMA Slides ©Stuart Russell and Peter Norvig, 1998

Chapter 3, Sections 1-5 58

153% 58 of 63 11 x 8.5 in

Start CS 564 laurent talks CS 561a Aima Adobe Acr... Microsoft Pow... Telnet - pollux... books Adobe Photos... 8:26 PM

Adobe Acrobat - [chapter03.pdf]
File Edit Document Tools View Window Help

```
graph TD; Arad1((Arad)) --> Zerind((Zerind)); Arad1 --> Sibiu((Sibiu)); Arad1 --> Timisoara((Timisoara)); Zerind --> Arad2((Arad)); Zerind --> Oradea1((Oradea)); Sibiu --> Arad3((Arad)); Sibiu --> Oradea2((Oradea)); Sibiu --> Fagaras((Fagaras)); Sibiu --> RimnicuVilcea((Rimnicu Vilcea));
```

AIMA Slides ©Stuart Russell and Peter Norvig, 1998

Chapter 3, Sections 1 5 59

153% 59 of 63 11 x 8.5 in

Start CS 564 laurent talks CS 561a Aima Adobe Acr... Microsoft Pow... Telnet - pollux... books Adobe Photos... 8:26 PM

Adobe Acrobat - [chapter03.pdf]
File Edit Document Tools View Window Help

```
graph TD; Arad1((Arad)) --> Zerind((Zerind)); Arad1 --> Sibiu((Sibiu)); Arad1 --> Timisoara((Timisoara)); Zerind --> Arad2((Arad)); Zerind --> Oradea1((Oradea)); Sibiu --> Arad3((Arad)); Sibiu --> Oradea2((Oradea)); Sibiu --> Fagaras((Fagaras)); Sibiu --> RimnicVilcea((Rimnic Vilcea)); Timisoara --> Arad4((Arad)); Timisoara --> Lugoj((Lugoj));
```

AIMA Slides ©Stuart Russell and Peter Norvig, 1998

Chapter 3, Sections 1 5 60

153% 60 of 63 11 x 8.5 in

Start CS 564 laurent talks CS 561a Aima Adobe Acr... Microsoft Pow... Telnet - pollux... books Adobe Photos... 8:27 PM

Iterative deepening complexity



- Iterative deepening search may seem wasteful because so many states are expanded multiple times.
- In practice, however, the overhead of these multiple expansions is small, because most of the nodes are towards leaves (bottom) of the search tree:

thus, the nodes that are evaluated several times (towards top of tree) are in relatively small number.

Iterative deepening complexity

- In iterative deepening, nodes at bottom level are expanded once, level above twice, etc. up to root (expanded $d+1$ times) so total number of expansions is:

$$(d+1)1 + (d)b + (d-1)b^2 + \dots + 3b^{(d-2)} + 2b^{(d-1)} + 1b^d = O(b^d)$$

- In general, iterative deepening is preferred to depth-first or breadth-first when search space large and depth of solution not known.

Bidirectional search

- Both search forward from initial state, and **backwards from goal**.
- Stop when the two searches meet in the middle.
- **Problem:** how do we search backwards from goal??
 - predecessor of node n = all nodes that have n as successor
 - this may not always be easy to compute!
 - if several goal states, apply predecessor function to them just as we applied successor (only works well if goals are explicitly known; may be difficult if goals only characterized implicitly).

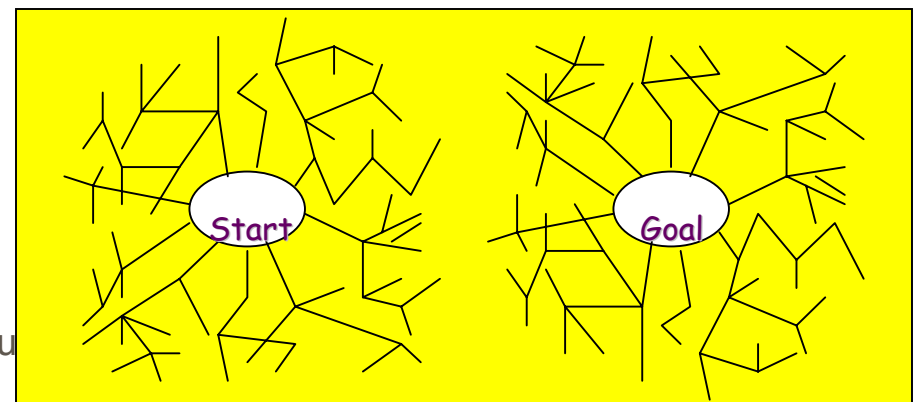

Bidirectional search

- **Problem:** how do we search backwards from goal?? (cont.)
 - ...
 - for bidirectional search to work well, there must be an efficient way to check whether a given node belongs to the other search tree.
 - select a given search algorithm for each half.

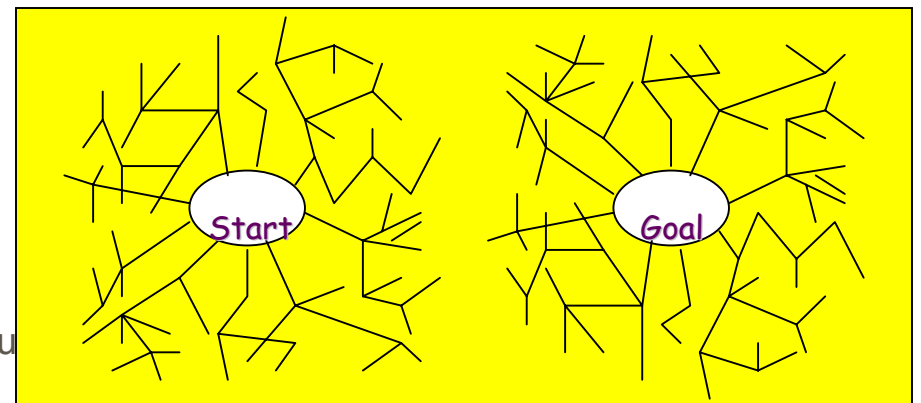

Bidirectional search



1. QUEUE1 \leftarrow path only containing the root;
QUEUE2 \leftarrow path only containing the goal;
2. WHILE both QUEUES are not empty
AND QUEUE1 and QUEUE2 do NOT share a state

DO remove their first paths;
create their new paths (to all children);
reject their new paths with loops;
add their new paths to back;
3. IF QUEUE1 and QUEUE2 share a state
THEN success;
ELSE failure;

Bidirectional search

- Completeness: Yes,
- Time complexity: $2 * O(b^{d/2}) = O(b^{d/2})$
- Space complexity: $O(b^{m/2})$
- Optimality: Yes

- To avoid one by one comparison, we need a hash table of size $O(b^{m/2})$
- *If hash table is used, the cost of comparison is $O(1)$*

Bidirectional Search

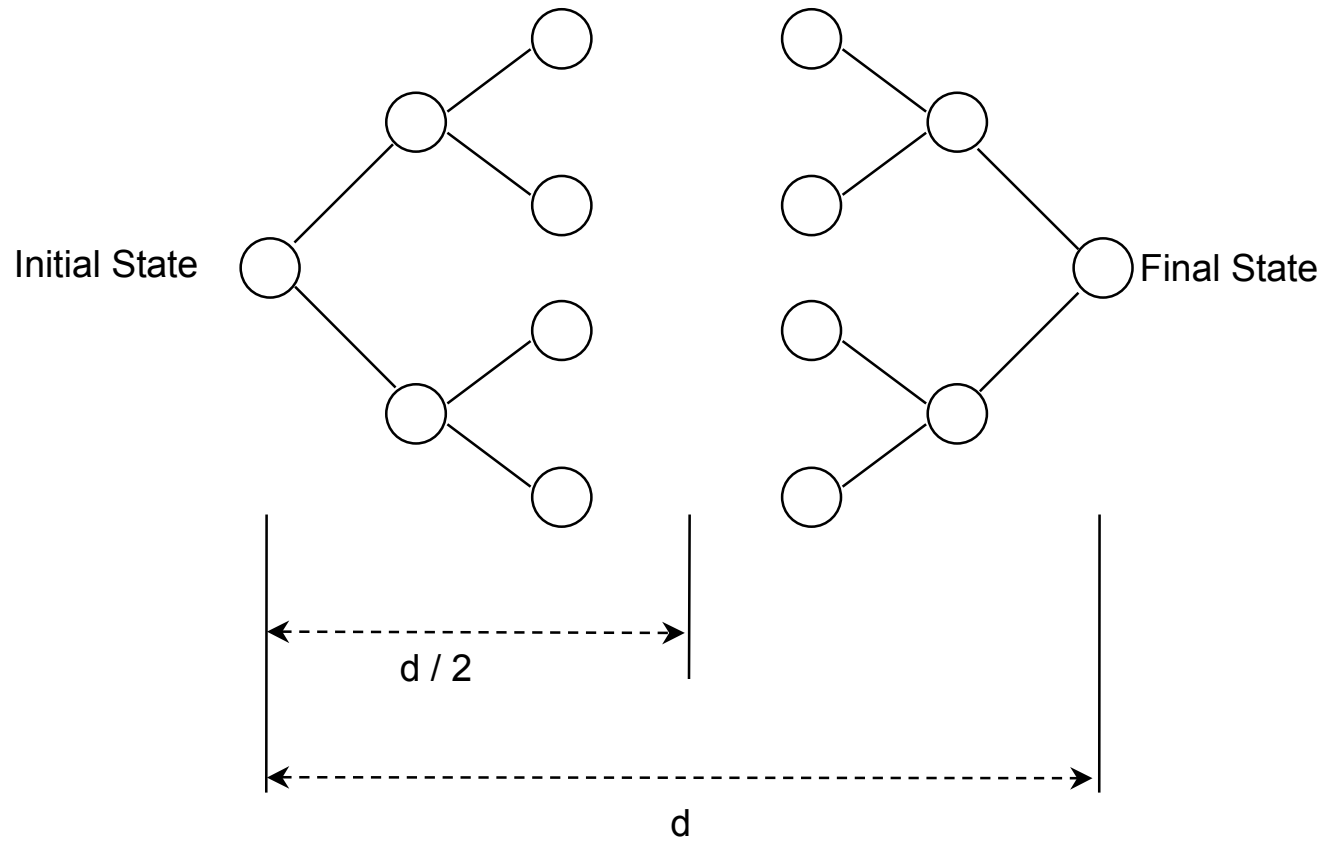

Bidirectional search



- Bidirectional search merits:
 - Big difference for problems with branching factor b in both directions
 - A solution of length d will be found in $O(2b^{d/2}) = O(b^{d/2})$
 - For $b = 10$ and $d = 6$, only 2,222 nodes are needed instead of 1,111,111 for breadth-first search

Bidirectional search



- Bidirectional search issues
 - *Predecessors* of a node need to be generated
 - Difficult when operators are not reversible
 - What to do if there is no *explicit list of goal* states?
 - For each node: *check if it appeared in the other search*
 - Needs a hash table of $O(b^{d/2})$
 - What is the *best search strategy* for the two searches?

Comparing uninformed search strategies

Criterion	Breadth-first	Uniform cost	Depth-first	Depth-limited	Iterative deepening	Bidirectional (if applicable)
Time	b^d	b^d	b^m	b^l	b^d	$b^{(d/2)}$
Space	b^d	b^d	bm	bl	bd	$b^{(d/2)}$
Optimal?	Yes	Yes	No	No	Yes	Yes
Complete?	Yes	Yes	No	Yes, if $l \geq d$	Yes	Yes

- b – max branching factor of the search tree
- d – depth of the least-cost solution
- m – max depth of the state-space (may be infinity)
- l – depth cutoff

Summary



- Problem formulation usually requires **abstracting away real-world details** to define a **state space** that can be explored using computer algorithms.
- Once problem is formulated in abstract form, **complexity analysis** helps us picking out best algorithm to solve problem.
- Variety of uninformed search strategies; difference lies in method used to **pick node that will be further expanded**.
- **Iterative deepening** search only uses linear space and not much more time than other uninformed search strategies.